



---

## *The Utah-400 Digital Routing Switcher*

**288x288 Redundant**



*System Setup and Operations*

---

---

---

---

## ***The Utah-400/288x288 Redundant Digital Routing Switcher Operators' Manual***

- Document Number: 82101-0073
- Document Version: 2.0
- Date: June 2, 2015
- Printed in U.S.A.

### ***Copyrights and Trademarks***

© 2015 Utah Scientific, Inc., All rights reserved. Any use or reproduction of this guide's contents without the prior written consent of Utah Scientific, Inc. is strictly prohibited.

- Utah 400 is a trademark of Utah Scientific, Inc.
- Windows references (all versions) are registered trademarks of Microsoft Corporation.
- All other product names and any registered or unregistered trademarks mentioned in this guide are used for identification purposes only and remain the exclusive property of their respective owners.

### ***Notice***

Information contained in this guide is subject to change without notice or obligation. While every effort has been made to ensure that the information is accurate as of the publication date, Utah Scientific, Inc. assumes no liability for errors or omissions. In addition, Utah Scientific, Inc. assumes no responsibility for damages resulting from the use of this guide.

### ***FCC Compliance (USA) and Digital Equipment Compliance (Canada)***

This equipment has been tested and found to comply with the limits for a Class A, digital device, pursuant to Part 15, Subpart B of the FCC Rules and the Canadian EMC Requirement (ICES-003). These limits are designed to provide reasonable protection against harmful interference when the equipment is operated in a commercial environment. This equipment generates, uses, and can radiate radio frequency energy and, if not installed and used in accordance with the instruction manual, may cause harmful interference to radio communications. Operation of this equipment in a residential area is likely to cause harmful interference, in which case, the user will be required to correct the interference at their own expense. Shielded cables must be used to ensure compliance with the FCC Class A limits.

---

---

## ***Declaration of Conformity***

### **Utah Scientific, Inc.**

4750 Wiley Post Way, Suite 150  
Salt Lake City, Utah 84116-2878 U.S.A.

We declare our sole responsibility that the Utah-400 Digital Routing Switcher is in conformance with the following standards:

#### **Emission**

- EN55022:1994+A1&A2

#### **Immunity**

- EN55024:1998
- EN61000-3-2
- EN61000-3-3

#### **Safety**

- IEC 60950-1:2001 /EN 60950-1:2001

Following the provisions of the Directive(s) of the Council of the European Union:

- EMC Directive 89/336/EED
- Low Voltage Electrical Directive 72/23/EEC

Utah Scientific, Inc. hereby declares that the product specified above conforms to the above Directive(s) and Standard(s).



---

---

## ***Important Safeguards and Notices***

This section provides important safety guidelines for the Operator and Service Personnel. Specific warnings and cautions are found throughout the guide where they apply, but may not appear here. Please read and follow the important safety information, specifically those instructions related to risk of fire, electric shock, or injury to persons.

### **Safety Symbols**



- Hazardous Voltage symbol



- Caution symbol. The product is marked with this symbol when it is necessary to refer to the manual to prevent damage to the product.

### **Warnings**

Please observe the following important warnings:



- Any instructions in this guide that require opening the chassis, changing a power supply, or removing a board, should be performed by qualified personnel only. To reduce the risk of electric shock, do not perform any service unless you are qualified to do so.
- Heed all warnings on the unit and in the operating instructions.
- Do not use this product in or near water. Disconnect AC power before installing any options or servicing the unit unless instructed to do so by this manual.
- This product is grounded through the power cord ground conductor. To avoid electric shock, plug the power cord into a properly wired receptacle before connecting the product inputs or outputs.
- Route power cords and other cables so they won't be damaged.
- The AC receptacle (socket) should be located near the equipment and be easily accessible.
- Disconnect power before cleaning. Do not use any liquid or aerosol cleaner - use only a damp cloth.



- Dangerous voltages exist at several points in this product. To avoid personal injury, do not touch exposed conductors and components while power is on. Do not insert anything into either of the systems two-power supply cavities with power connected.
- Do not wear hand jewelry or watches when troubleshooting high current circuits, such as power supplies. During installation, do not use the door handles or front panels to lift the equipment as they may open abruptly and injure you.
- To avoid fire hazard when replacing fuses, use only the specified correct type, voltage and current rating as referenced in the appropriate parts list for this product. Always refer fuse replacement to qualified service personnel.
- Have qualified personnel perform safety checks after any service.

#### **Cautions**

Please observe the following important cautions:



- When installing this equipment do not install power cords to building surfaces. To prevent damage when replacing fuses, locate and correct the problem that caused the fuse to blow, before reconnecting power.
- Use only specified replacement parts

#### **Notices**

Please observe the following important notes:



- When the adjacent symbol is indicated on the chassis, please refer to the manual for additional information.
- For the HD-2020 Chassis and Master Control Panel, refer to “Connecting and Disconnecting Power” - Chapter 2 (Hardware Installation).

---

---

## *Company Information*

### **Utah Scientific, Incorporated**

**4750 Wiley Post Way, Suite 150  
Salt Lake City, Utah 84116-2878 U.S.A.**

- Telephone: +1 (801) 575-8801
- FAX: +1 (801) 537-3098
- Technical Services (voice): +1 (800) 447-7204
- Technical Services (FAX): +1 (801) 537-3069
- E-Mail -General Information: [info@utsci.com](mailto:info@utsci.com)
- E-Mail -Technical Services: [service@utsci.com](mailto:service@utsci.com)
- World Wide Web: <http://www.utahscientific.com>
- **After Hours Emergency:** +1 (800) 447-7204. Follow the menu instructions for Emergency Service.

---

---

## ***Warranty Policies***

### **Hardware Warranty**

Utah Scientific, Inc. warrants to the original purchaser that the Utah Scientific hardware is free from defects in materials and workmanship and will perform substantially in accordance with the accompanying written materials under normal use and service for a period of ten (10) years from the date of shipment. Any implied warranties on hardware are limited to ten (10) years. Some states/jurisdictions do not allow limitations on duration of an implied warranty, so the above limitation may not apply to certain specific purchasers.

### **Software Warranty**

Utah Scientific warrants that the software will perform substantially in accordance with the accompanying written materials for a period of one (1) year from the date of shipment.

### **Customer Remedies**

For the first one (1) year after purchase of the software and the first ten (10) years after the date of purchase of the hardware, Utah Scientific's and its suppliers' entire liability and purchaser's exclusive remedy shall be, at Utah Scientific's option, either:

- Return of the price paid, or
- Repair or replacement of the software or hardware that does not meet the above warranties and is returned to Utah Scientific under the returned materials authorization (RMA) process with freight and forwarding charges paid.

After the initial warranty periods, purchaser's exclusive remedy is the repair or replacement of the hardware upon payment of a fixed fee to cover handling and service costs based on Utah Scientific's then-current price schedule. The above warranties are void if failure of the software or hardware has resulted from an accident, abuse, or misapplication. Any replacement software or hardware will be warranted for the remainder of the original warranty period or thirty (30) days, whichever is longer.

---

---

***No other warranties.*** To the maximum extent permitted by applicable law, Utah Scientific and its suppliers disclaim all other warranties, either express or implied, including, but not limited to implied warranties of merchantability and fitness for a particular purpose, with regard to the software, the accompanying written materials, and any accompanying hardware. This limited warranty gives the purchaser specific legal rights. These rights may vary in certain states/ jurisdictions.

***No liability for consequential damages.*** To the maximum extent permitted by applicable law, in no event shall Utah Scientific or its suppliers be liable for any damages whatsoever (including without limitation, damages for loss of business profits, business interruption, loss of business information, or any other pecuniary loss) arising out of the use of or inability to use Utah Scientific products, even if Utah Scientific has been advised of the possibility of such damages. Because some states/jurisdictions do not allow the exclusion or limitation of liability for consequential or incidental damages, the above limitation may not apply in those circumstances.



---

**Table of Contents**

---

---

**Table of Contents**

---

**CHAPTER 1***Introduction*

In This Guide .....	1-1
Conventions .....	1-3
Abbreviations .....	1-4
Terms .....	1-5
Routing Switcher Basics .....	1-6
Switching Matrix .....	1-7
Signal Levels .....	1-8
The Utah-400 Routing Matrix .....	1-9
System Configurations .....	1-11
Sample Configurations .....	1-11

**CHAPTER 2***Hardware Installation*

In This Chapter .....	2-1
Unpacking and Inspection .....	2-2
Installing Physical Equipment .....	2-3
Mounting Equipment in Rack Frames .....	2-3
Installing the Utah-400 Digital Routing Switcher .....	2-3
Installing the MX-Bus Cables .....	2-7
Interconnecting the SC-4 and Utah-400 Frames .....	2-7
Connecting the AES Reference Signal .....	2-9
Determining and Setting Router Signal Levels .....	2-9
Offset Switch .....	2-11
Video/Unbalanced Digital Audio Input & Output Signals .....	2-12
Installing the Analog Audio Input and Output Cables .....	2-16
Connecting and Disconnecting Power .....	2-21
DC Connectivity .....	2-22
Pre Power-Up Checks .....	2-23
Hardware Checkout .....	2-24

---

---

**CHAPTER 3**

*Configuration and Operation*

In This Chapter ..... 3-1

Utah 400 SC-4 Control ..... 3-2

Module Array – Panel Front ..... 3-4

Operation ..... 3-5

    Alarm Indication ..... 3-5

    Ethernet and RS-422 Connection ..... 3-5

    Crosspoint Cards Maintenance ..... 3-6

    Input and Output Card Removal and Replacement ..... 3-7

    Crosspoint Card Removal and Replacement ..... 3-7

Fan Service ..... 3-8

    Power Supply ..... 3-9

**CHAPTER 4**

*Utah-400 Components*

In This Chapter ..... 4-1

Video Input ..... 4-2

    SD Video Input ..... 4-2

    Multi-Rate Input ..... 4-3

    Analog to Digital ..... 4-3

    Reclocking Input Expansion Card ..... 4-6

    UTAH-400 3G Input Card ..... 4-7

Video Output Boards ..... 4-9

    SD-Output ..... 4-9

    HD-Output (Multi-Rate output card) ..... 4-10

    Digital Video to Analog Converter Output card ..... 4-10

    Multi-Rate Output Board ..... 4-12

    Control Description ..... 4-14

    UTAH-400 3G Output Board ..... 4-15

Fiber Interface - (Optional) ..... 4-17

    Specification Detail ..... 4-18

    Fiber Output LED Indications ..... 4-19

Video Crosspoint Board (Redundant) ..... 4-21

    Indicators ..... 4-21

Rear Panel Considerations ..... 4-23

    MX Bus ..... 4-23

    Dip Switches ..... 4-23

---

**Table of Contents**

---

Monitor Output .....	4-23
Analog Blackburst .....	4-24
Power Supplies .....	4-24
LED Indications .....	4-25
Audio Input .....	4-27
Audio Input Board .....	4-27
Audio Output .....	4-28
Audio Output Board .....	4-28
Deluxe Output Board .....	4-29
Board Indicators .....	4-30
Deluxe Output Module .....	4-31
DAC Output Module .....	4-33
ADC Input Module .....	4-35
Audio Crosspoint Board .....	4-37
Front Edge Card Indicators (Left Bank) .....	4-38
Front Edge Card Indicators (Right Bank) .....	4-38
Audio Crosspoint Adjustments .....	4-39
Time Base Module .....	4-39
Fuses .....	4-42
Test points (front of Crosspoint card) .....	4-43

**CHAPTER 5***Troubleshooting*

In This Chapter .....	5-1
Subsystem Level Troubleshooting .....	5-2
Main Troubleshooting Chart .....	5-2
Video Subsystem Troubleshooting Table .....	5-4
Audio Subsystem Troubleshooting Table .....	5-5
Power Subsystem Troubleshooting Table .....	5-6
Power Supply Alarms .....	5-6
Control Subsystem Troubleshooting Table .....	5-7
System Controller Alarms .....	5-8
Control Panel Troubleshooting .....	5-9
UNET Panels .....	5-9
Ethernet Panels .....	5-9

---

---

**APPENDIX A**

*Specifications*

In this Appendix ..... A-1

Power ..... A-2

Input Power and DC Power Specifications ..... A-2

Digital Video ..... A-3

    Digital Video Specifications ..... A-3

Digital Audio ..... A-4

    Digital Audio Specifications ..... A-4

High Definition SDI Video ..... A-5

    High Definition SDI Video Specifications ..... A-5

Reference ..... A-5

    Reference Specifications ..... A-5

Control ..... A-6

    Control Specifications ..... A-6

Alarms ..... A-7

    Alarm Specifications ..... A-7

Physical ..... A-8

    Physical Specifications ..... A-8

Regulatory ..... A-8

    Regulatory Specifications ..... A-8

Connector Suppliers and USI Part Numbers ..... A-9

    Connector Suppliers ..... A-9

**APPENDIX B**

*The Debug Port*

The Debug Cable ..... B-2

Using the Debug Port ..... B-3

    Startup Display ..... B-4

    Main Menu Display ..... B-4

    FPGA Memory Status ..... B-5

    Verifying the Software Version ..... B-5

    Checking the Router Crosspoint Status ..... B-6

    IO Card Information ..... B-7

    Checking Input / Output Card Information ..... B-9

    IO Information – full display ..... B-10

    Hardware Status ..... B-11

---

**Table of Contents**

---

External PS Status .....	B-12
Crosspoint Voltage (Levels) .....	B-14
'DC CONV readings' .....	B-14

**APPENDIX C***The Utah-400 Digital Audio Breakout Panel*

Scope .....	C-2
The AES Breakout Panel Kit .....	C-2
Description of the AES Breakout Panel .....	C-2
Installation of the AES Breakout Panel .....	C-2
Label Instructions for the Utah-400 Breakout Panel .....	C-5
Scope .....	C-5
Application .....	C-5

**APPENDIX D***Crosspoint Card Firmware Upgrade*

Scope .....	D-1
Process .....	D-1

**APPENDIX E***MADI Board Configuration*

MADI IX8 / MADI IX16 Input Modules .....	E-2
MADI Input Slot Board Installation .....	E-4
MADI Input Rear Panel Cabling .....	E-5
MADI OX8 / MADI OX16 Output Module .....	E-6
MADI Output Slot Board Installation .....	E-9
MADI Output Rear Panel Cabling .....	E-10

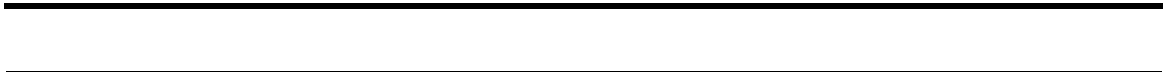

---

*In This Guide*

This guide provides instruction for the installation, configuration, and operation the Utah Scientific, Utah-400 288 Redundant Router. This router contains redundant crosspoints with 36 slots for both the input and output and cards, and stands 15 rack units in height.

The following chapters and appendices are included:

- **Chapter 1**

"Introduction" summarizes the guide, describes basic router operation and describes the hardware and software components of the Utah-400 Digital Routing Switcher.

- **Chapter 2**

"Hardware Installation" provides instructions for installing the Utah-400 Digital Routing Switcher in your facility.

- **Chapter 3**

"Configuration and Operation" provides specific information regarding the configurations of this unit, and necessary equipment handling (operation).

- **Chapter 4**

"Utah-400 Router Components" provides basic information about the Input, Output, Crosspoint, Interface board and Power Supplies. Included is general information about LED indicators and alarms present on each board type.

- **Chapter 5**

"Troubleshooting" looks at some of the common hardware and software problems, diagnostics and solutions available to the user on site. Included in this section is information on the various avenues to contact Utah Scientific Technical Services and tips on discussing equipment problems.

- **Appendix A**

"Specifications" lists all system specifications, including Audio, Video, physical, power, and regulatory.

- **Appendix B**

"The Debug Port" contains information regarding the current Utah 400 firmware, along with setup and use of the system Debug Cable.

- **Appendix C**

"The Utah 400 Digital Audio Breakout Panel" applies to the installation and operation of the AES Digital Audio Break Out Panel, a component designed to simplify the installation of the Utah-400 Balanced Digital Audio Routing System.



---

## *Conventions*

The following conventions are used throughout this guide:

- Connectors and terminators will be indicated by bold, upper case text in Arial Black font.  
For example:
  - Connect the **MX-Bus** to **J-1**
- **Operator Actions** will be indicated in Helvetica Bold where a board is inserted, removed and/or an action is required in the Troubleshooting or configuration sections of this manual. There will usually be a graphic to accompany the instruction(s). For example:
  - **Insert** the expansion Input board in slot 6.
  - **Switch** the suspected bad input **to a known good input** to verify output "X".
- The use of bullets indicates a random order of operation or to draw the readers attention to specific items.
  1. The use of numbers in specific operations or lists indicates a "**recommended order of operation**" to perform specific tasks. Bulleted items may be below numbered items to highlight tasks or indicate the operation(s) may be performed at random.

---

## *Abbreviations*

The following abbreviations may be used in this guide: See Appendix A for an additional Glossary of Terms and further definitions.

**TABLE 1. Common Abbreviations and Mnemonics**

<b>Abbreviation</b>	<b>Description</b>
ATR	Audio Tape Recorder
AES	Audio Engineering Society
CPU	Central Processing Unit
DTR	Digital Tape Recorder
EBU	European Broadcast Union
ENET	Ethernet
HDTV	High Definition Television
I/O	Input / Output
IP	Internet Protocol
JPEG	Joint Photographic Experts Group
M-JPEG	Motion – JPEG
MPEG	Motion Picture Experts Group
MX-Bus	Utah Router Control Comm. Bus
RMS	Router Management System
RU	Rack Unit
SDI	Serial Digital Interface
U-Net	Utah Control Panel Comm. Network
UTP	Unshielded Twisted Pair
VTR	Video Tape Recorder

---

## *Terms*

The following terms are used throughout the documentation in this guide:

- **"Operator"** and **"User"** refer to the person using or operating the Utah-400 Digital Router System.
- **"System"** refers to the entire interconnected Utah-400 System including control panels, routers, software, and chassis.
- **"Mainframe"** refers to the Utah-400 chassis plus redundancy.
- **"Input"** refers to an audio or video signal source that is connected to the Utah-400 main frame.
  - One video input represents one High Definition or Serial Digital Interface video output signal.
  - One audio input represents a single monophonic track from an analog audio source.
  - One digital audio input represents two tracks (left and right channel) from a digital audio source.
- **"Source"** refers to an audio or video device whose output signals are connected to the Utah-400 mainframe inputs. Examples of audio / video sources are ATR's, VTR's, DTR's, cameras, video / audio routers, audio mixers, graphics systems, and satellite feeds.
- **"Output"** refers to the Utah-400 audio or video signals from the Utah-400 "Outputs", which are connected to the 'destination device'. This term also includes the physical output connectors on the frame.
- **"Destination"** refers to the device, which is receiving the Utah-400 output signal. This could include VTRs, monitors, satellite feeds, or video / audio routers.
- **"Signal Level"** refers to the logical level of the audio / video routers in relation to the entire connected system(s). Typically, the Utah-400 occupies levels above 1, with master control occupying the lowest logical level.
- **"Hot Swappable"** refers to a printed circuit board, which can be removed or replaced with system power "on".
- **"Control Panel"** refers to the physical human interface used to control the various systems in use.
- **"Display"** is the 'LCD Display' on the panels in use.

- **"Monitor"** refers to the monitor attached to the monitor matrix port of a video or audio router system.
- **"High Definition"** " refers to signals conforming to the SMPTE -292 specification. The typical high definition data rate is 1.485 Gb/sec or 1.483 Gb/sec and a 16:9 Aspect Ratio Picture characterizes this technology.
- **"Serial Digital" Interface (SDI)"** refers to the serial digital video signal operating at either SMPTE -259 in ABCD or SMPTE -344.

---

### *Routing Switcher Basics*

A routing switcher is a specialized form of broadcast equipment that allows the user to connect large numbers of source and destination devices together electronically – without patching or running cables across floors and without significant signal loss.

The routing switcher solves connectivity problems and increases signal qualities in a wide variety of applications. The technologies of routing switchers now include the standard analogue, digital video, digital audio, and increasingly the high definition formats.

The routing switcher provides the user with the following advantages:

- Many signal levels (determined by the system size) may be switched simultaneously.
  - A simple route connects (switches) one signal level from one source (for example a VTR) to one destination (a monitor).
    - A complex route would connect multiple signal levels from one source to multiple destinations, including tie lines. For example, a satellite feed to a group of VTRs and monitors.
- Audio and video signal levels can be switched in groups (all follow takes) or individually (breakaway takes). Any input can be switched to any output, limited only by the matrix size.
- The Routing Switcher may be controlled manually via control panels, or with computer controlled automation.

## Switching Matrix

A switching matrix is the internal array of inputs, crosspoints and outputs that allow a routing switcher to perform the task of routing signals from sources to destinations. The figure below illustrates a simple 10 X 10 switching matrix – with 10 Inputs and 10 Outputs.

Note the following points regarding the illustration:

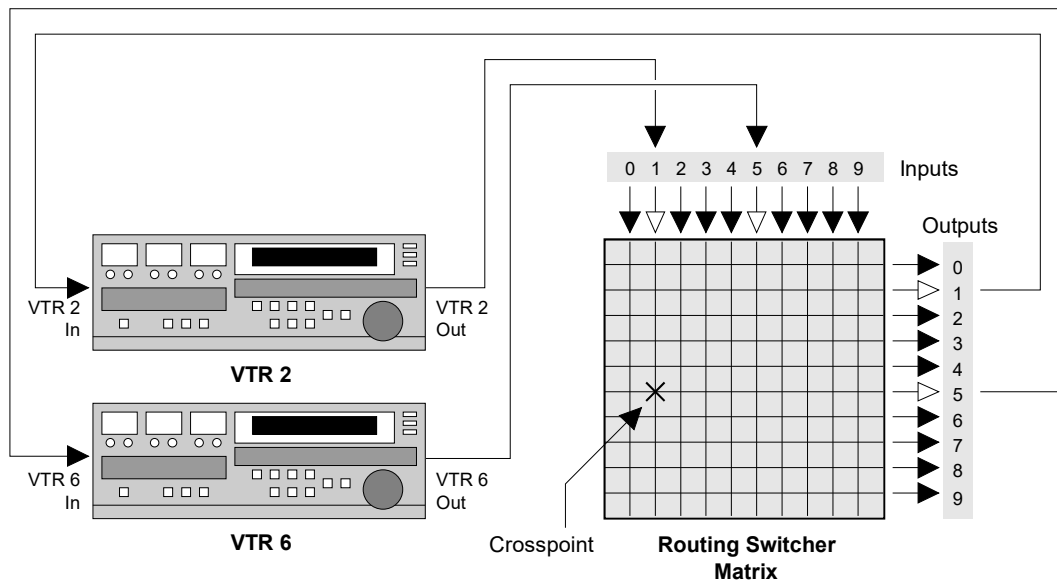

- Each VTR is fully connected to the matrix – all audio/video inputs and outputs.
- A cross-point (represented by an **X**) is the internal electronic connection of the input to the output – either audio or video.
- When the cross-point is turned "**ON**" the connection is made between the source and destination. The action of turning the cross-point on is known as making a "**Take**".
- When an entire audio/video array is connected in this manner, from all of the devices in your facility, you have full routing flexibility.
- Without re-cabling or re-patching, a device can play back one moment (as a source) and record the next moment (as a destination).

## Signal Levels

A "signal level" represents one of many specific types of audio or video elements that a routing switcher is capable of handling. The typical signals capable of being switched are:

- Analog Video
- Analog Audio (stereo with left and right channels).
- Digital Video
- Digital Audio (dual channel – stereo pair)
- High Definition Video.

Some systems may be configured with one signal level, while others may be configured with multiple signal levels.

While the diagram in the previous section shows only one signal level, a multi-signal level system is capable of routing any combination up to 32 levels – each with its own matrix and cross-points.

The figure below illustrates **eight signal levels** in a 10 X 10 matrix system.

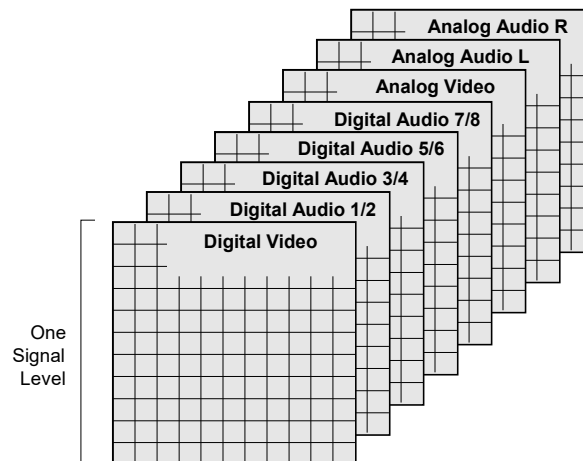

Signal routers are typically much larger than a 10 X 10 matrix, depending on user needs. Each signal level may also have different sizes of matrices and do not all need to be the same size.

### The Utah-400 Routing Matrix

The Utah-400's unique matrix technology allows for a greater flexibility of input and output combinations available to the user. Each input or output board contains eight signal paths so the user can expand in groups of eight up to the maximum capacity of the router. These I/O cards can be HD, SD, or Analog in a video router, and AES or analog in an analog router.

Features of this technology include signal presence indicators on both the input and output boards. The status of the router input and output states can be continuously monitored via the debug port (see Appendix B).

Refer to the Utah-400 Matrix Block Diagram for the following signal routing description.

The input signal is received and equalized on the input board. A valid input will illuminate the Signal Presence Detector LED and also status at the debug port.

From this point the signal is routed to the crosspoint, where the operator has made a "Take", selecting the routing path of this input to its output.

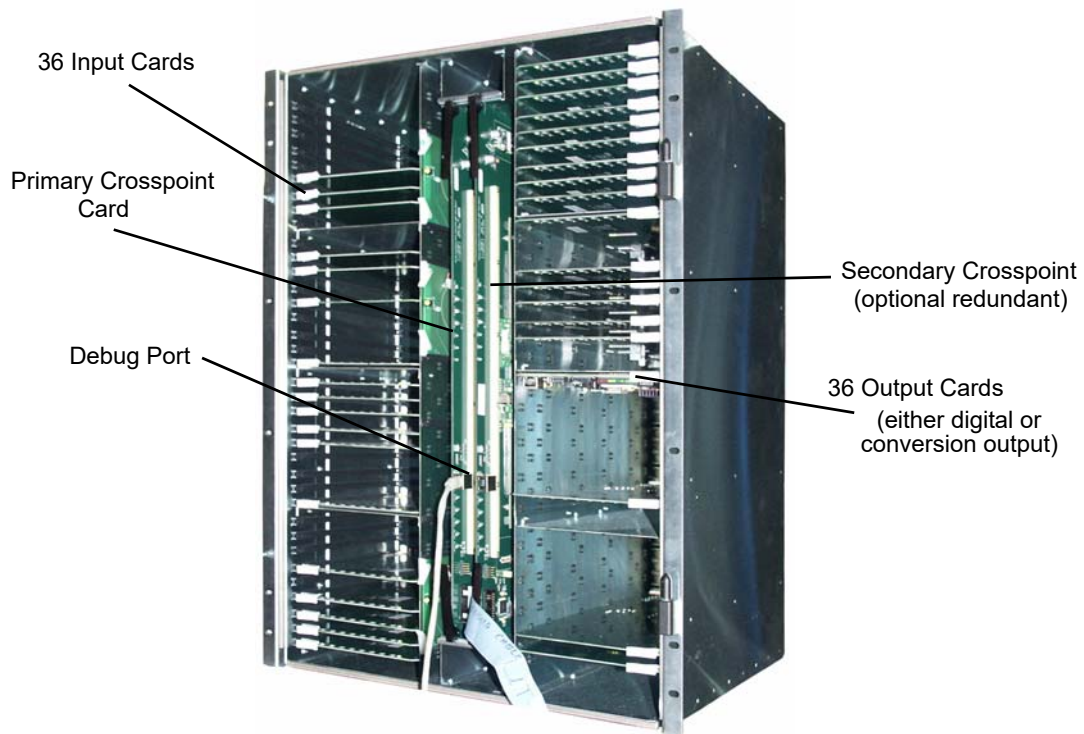

FIGURE 1-1. Utah-400 (front view)

The output from the crosspoint is directed to its proper path on the output bus and the appropriate output board slot. When the output board detects a valid output signal, it will illuminate the appropriate Signal Presence LED. From this point the output signal is sent to its output driver and its BNC.

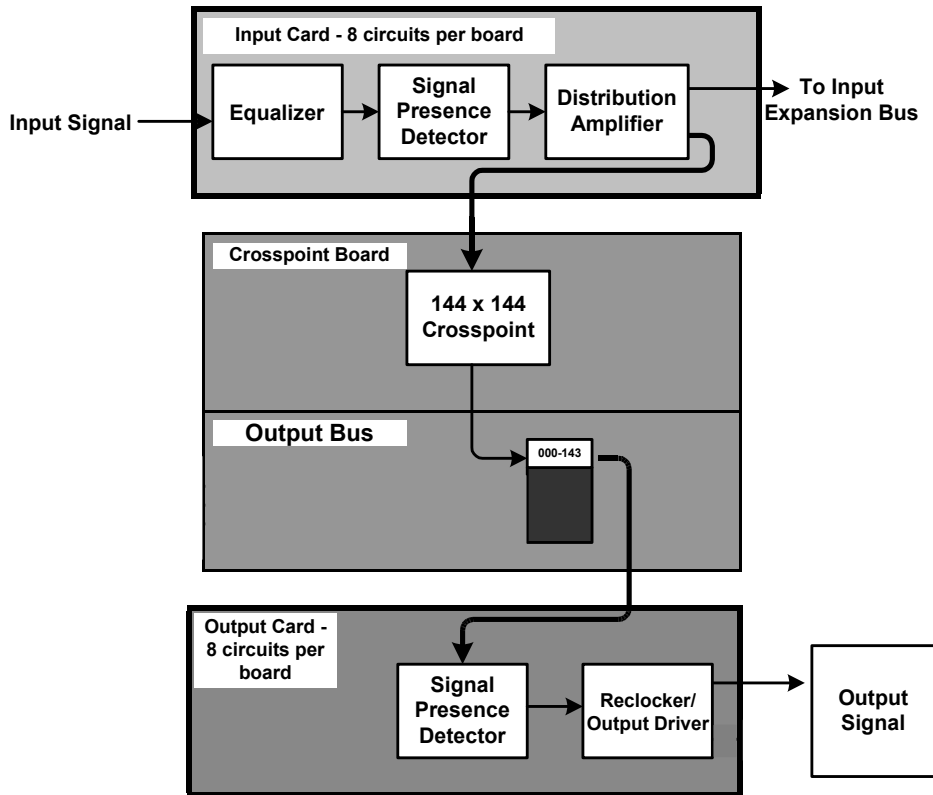

FIGURE 1-2. The Utah-400 Matrix Block Diagram



---

## System Configurations

### Sample Configurations

The 288R configuration is shown below.

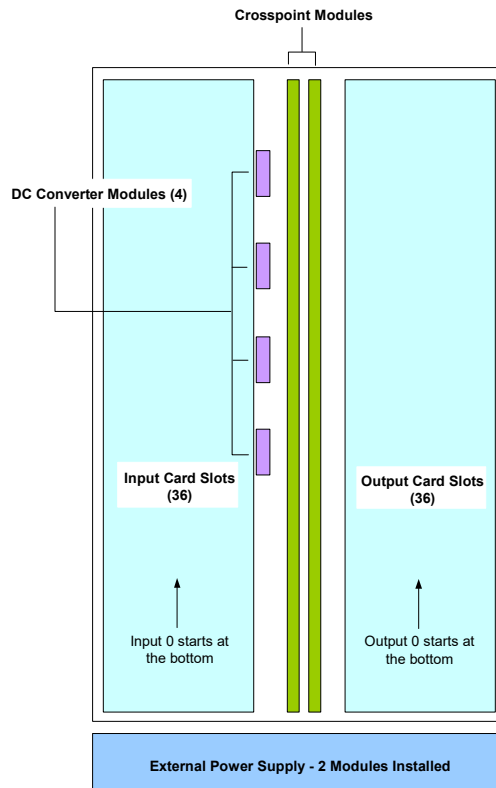

**FIGURE 1-3. The Utah-400 288 x 288 Configuration**

- The 288 x 288 Router Includes: - *redundant card optional*
  - 2) Crosspoint Board (288 x 288)
  - 36) Input Boards (000 – 287)
  - 36) Output Boards (000 – 287)
  - 1) External Power Supply Frame
  - 4) DC Converter Modules



*In This Chapter*

This chapter provides instructions for installing your Utah-400 router in your facility. The following topics are covered:

***Caution:*** *To avoid damage to the system, **do not connect AC power until the hardware is fully installed.***

Unpacking and Inspection .....	2-2
Installing Physical Equipment .....	2-3
Mounting Equipment in Rack Frames .....	2-3
Installing the MX-Bus Cables .....	2-7
Installing the Analog Audio Input and Output Cables ....	2-16
Connecting and Disconnecting Power .....	2-21
Pre Power-Up Checks .....	2-23
Hardware Checkout .....	2-24

## *Unpacking and Inspection*

When you receive your Utah-400 system, inspect each shipping carton for signs of damage. Contact your dealer and shipper immediately if you suspect any damage has occurred during shipping. Check the contents of each carton against your Utah Scientific order and verify them against the shipping manifest. If any items are missing, contact your dealer or Utah Scientific immediately.

Save the shipping box and material for future use, in case the unit may have to be shipped back to Utah Scientific.

**Caution: The Utah-400 router weighs approximately 150 pounds; with shipping materials and accessories the box weight may equal more than ninety pounds.**

Each router is wrapped in anti-static plastic prior to boxing up. Figure 2-1 shows the typical packaging of a single Utah-400 router.

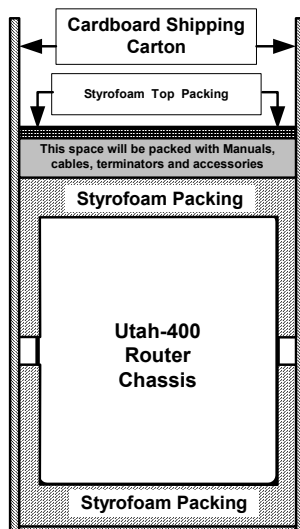

**FIGURE 2-1. Utah-400 Packaging**

### **Recommended unpacking method:**

1. With carton setting upright, open the top.
2. Remove the Styrofoam packing material in the top of the box.
3. Remove the accessories.

4. Remove the Styrofoam packing from the top of the Utah-400.
5. Grasp the sides of the Utah-400 and gently pull it up and out of the bottom Styrofoam packing material and box.
6. Place the Utah-400 on a stable bench or cart.
7. With the Utah-400 sitting on a bench or cart, remove the anti-static wrap covering the router and save for future use.
8. Move the router to the installation site.

---

### *Installing Physical Equipment*

Installation of your Utah-400 Video and/or Audio router may require some or all of the following steps:

1. Mounting equipment in rack frames.
2. Installing MX-Bus cables.
3. Connecting the AES Reference Signal.
4. Determining and Setting the Router Signal Level(s).
5. Installing Audio/Video signal cables.
6. Connecting power.
7. Connecting the SMPTE alarm port.
8. Hardware checkout.

---

### *Mounting Equipment in Rack Frames*

#### **Installing the Utah-400 Digital Routing Switcher**

Use the following steps to install the Utah-400 Systems into the rack frames:

1. Determine the vertical layout of your frames before you begin the installation. Please note:
  - You may wish to place blank panels between the systems to increase ventilation and make cabling easier.
  - You may wish to install the systems in a way to reflect the priority of audio and video signal levels.

- The 1 rack unit power supply frame must be installed directly below the 15 rack unit audio or video frame.
  - **For example:** If digital video is signal level 1 and digital audio is signal level 2, the digital video may occupy a lower position in the rack frame.

**Note:** See Figure 2-2 for an example rack frame layout.

2. Once your layout is determined, remove the front cover from the Utah-400 and set it aside.

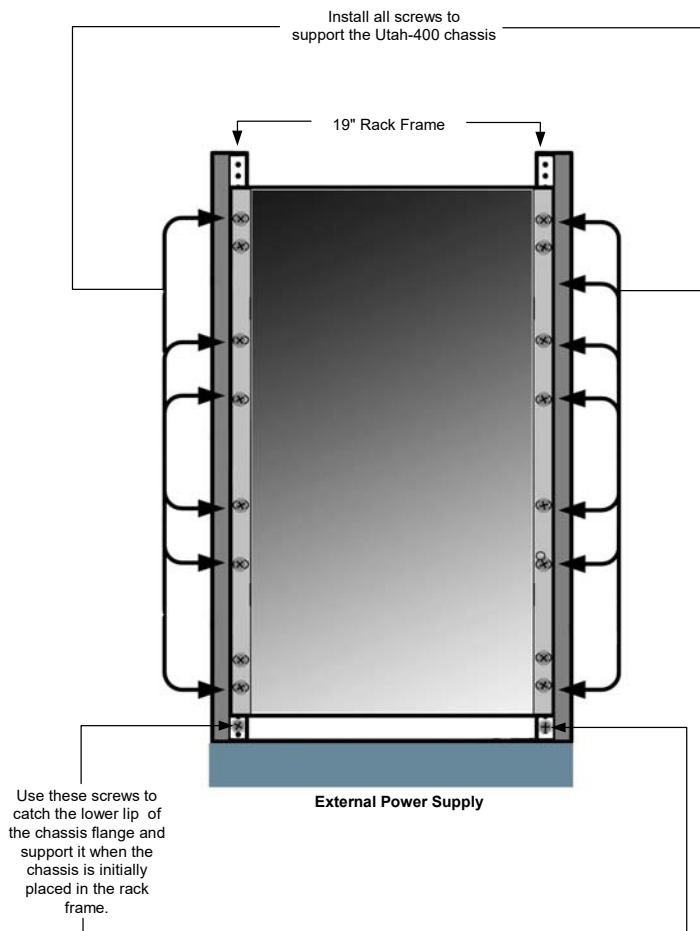

**FIGURE 2-2. Utah-400 Chassis Mounted in 19" Rack Frame**

---

3. Remove the shipping braces and set them aside.
4. Install the Utah-400 chassis' in the 19" rack frame.

**Note:** *The 288R chassis weighs close to 150 pounds; Utah Scientific recommends a minimum of two persons, preferably three, to install the chassis in the rack frame. Install all mounting screws in the front of the chassis; the entire weight of the router and cables are supported by the chassis side-frames.*

- a. Determine the height to mount the Utah-400 in the rack frame.
- b. Install two rack screws 3/4 of the way into the empty rack frame below the height determined in step a, above (leave a 1/8" gap). These screws will be used to support the weight of the chassis when it is moved into the rack frame. See Figure 2-4.
- c. With two persons, pick the chassis up from the shipping carton at the left and right side frames.
- d. Move the chassis to the 19" rack frame and carefully slide it into the rack frame, hooking the flange of the chassis above the rack screws installed in step b., above. (Figure 2-4).

**Note:** *An alternative method is to support the Utah-400 Chassis with a shelf or similar support and align the mounting holes accordingly.*

- e. With the chassis resting on the lower rack screws, carefully lift the left side frame, align the lowest chassis frame mounting hole with a rack frame threaded hole and start rack screw. Repeat for the right hand side frame.
- f. Once the lower chassis rack screws are in place, snug both sides up, but do not tighten.
- g. Align remaining mounting holes, install remaining rack screws through mounting holes, then snug them down.
- h. Finally, tighten all rack screws installed in the chassis mounting holes.

5. Replace all front covers when the installation is complete.

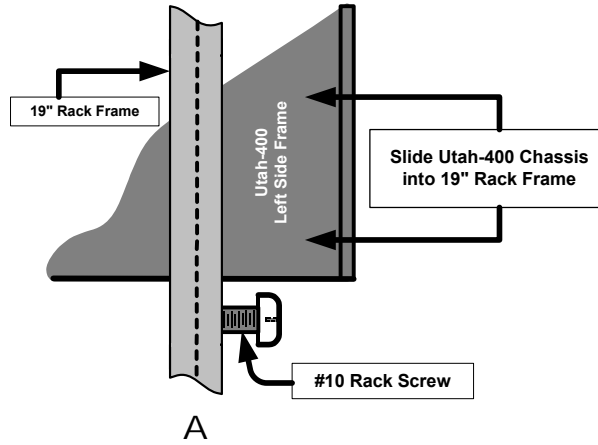

FIGURE 2-3. Sliding the Utah-400 Chassis into Rack Frame

---

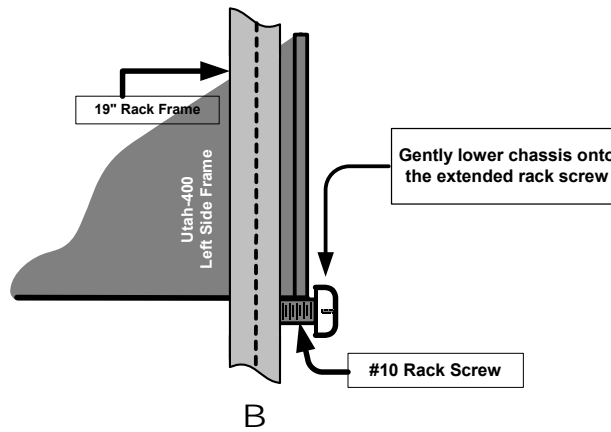

FIGURE 2-4. Lowering the Utah-400 Chassis on the Rack Screw

---



---

## Installing the MX-Bus Cables

The Utah-400 routing system utilizes the MX-Bus control system. It must be connected to the SC-4 control system to switch its inputs and outputs. In addition, the proper levels and offsets must be set on the Utah-400 routing system(s) so they will operate on the proper signal levels.

The MX-Bus is a daisy chain configuration, must not exceed 300 feet (91.4 meters) in length; and must be terminated at both ends of the daisy chain.

Your Utah-400 router is shipped standard with:

- One MX-Bus Cable – 10 ft. (USI Part Number: 80229-10). Other lengths are available and may be ordered through Utah Scientific sales at 1-800-453-8782.

### Interconnecting the SC-4 and Utah-400 Frames

The MX-Bus interconnection to the Utah-400 typically starts at the SC-4 control system and is terminated at the last physical Utah-400 chassis. The actual physical arrangement depends on the site placement of the various physical components.

The following illustration shows a typical MX-Bus installation.

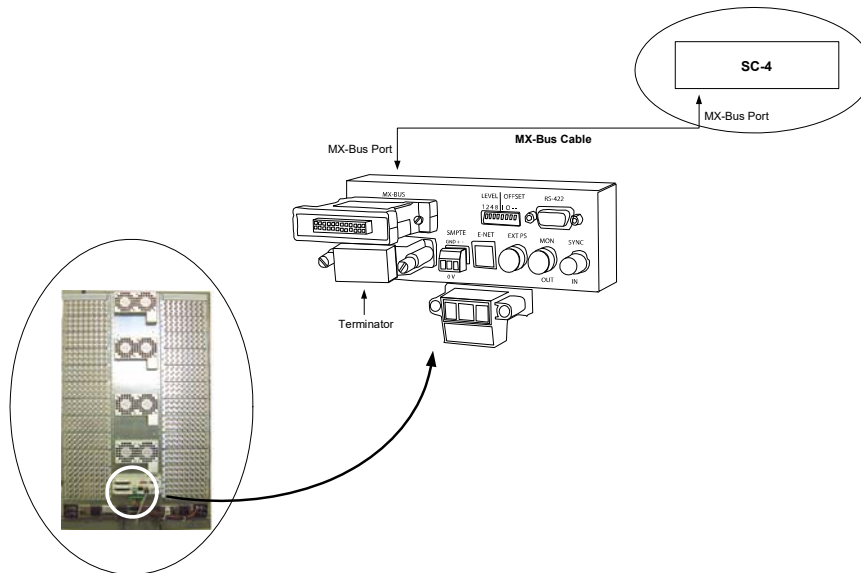

**FIGURE 2-5. The MX-Bus Installation to an SC-4 Controller**

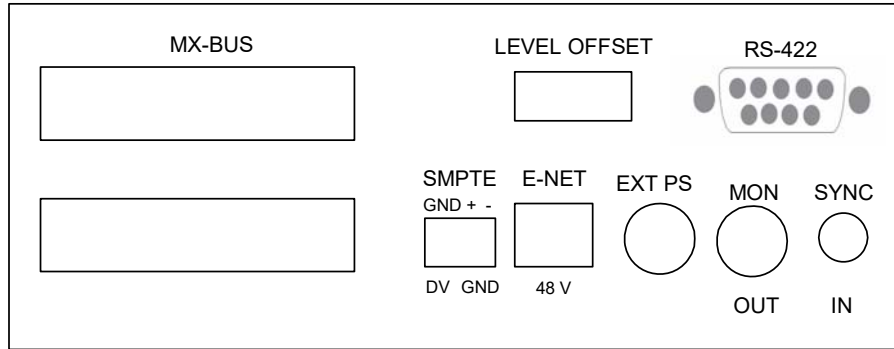

FIGURE 2-6. Control Backplane

The following illustration is a block diagram showing the Utah-400 in an MX-Bus daisy chain with other Utah Scientific equipment.

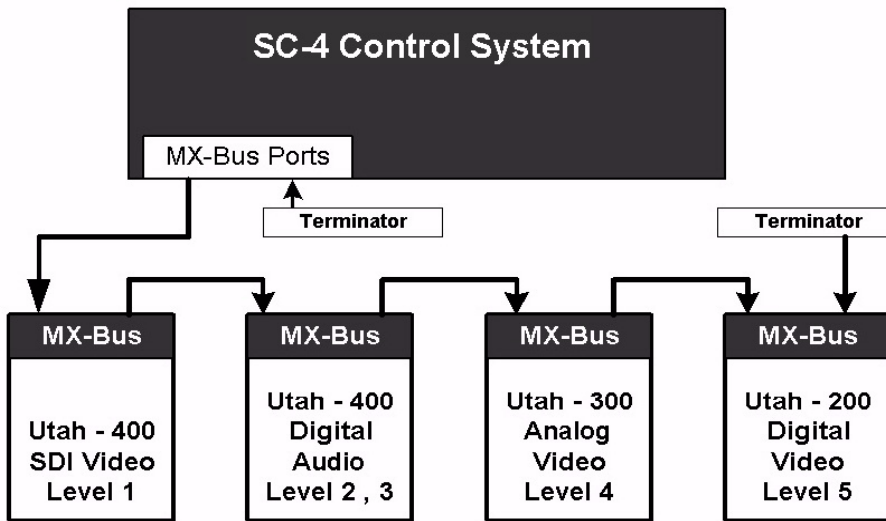

FIGURE 2-7. Block Diagram of the MX-Bus Daisy Chain.

### Connecting the AES Reference Signal

The AES Reference input corresponds to the Sync Input BNC on the back of the 288R chassis.

This BNC signal connection is terminated in 75 Ohm.

The Reference signal is required so the Utah-400 Digital Audio Router can switch on the **frame boundary**. Using the Sync signal avoids the possibility of clicks in the digital audio while switching.

The following signal is acceptable to use as the Utah-400 AES Reference:

- AES Sync must be AES-3.
  - The following illustration shows the typical AES Reference cabling.

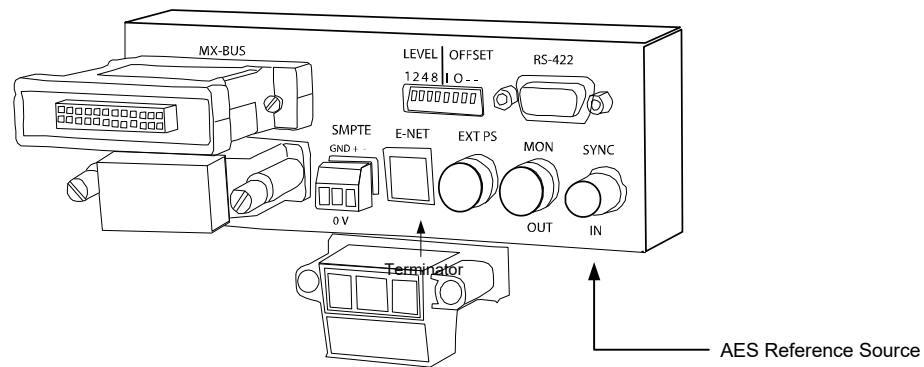

FIGURE 2-8. AES Reference Cabling (288x288 shown)

### Determining and Setting Router Signal Levels

Signal levels are preset at the factory and tested during manufacturing, determined by customer input and requirements. The installation of your new Utah-400 Router should not require any signal level changes to operate after the new installation.

By definition, a signal level represents distinct elements of the broadcast system. These individual elements include, but are not limited to, High Definition Video, SDI Video, Digital Audio, Analog Video, Analog Audio and Data Routers. For additional information relating to signal levels, refer to the Introduction, Page 1-6.

Should you ever need to change the signal level of your router it is useful to determine:

- What new signal level is required.
- If other signal levels will have to be modified to accommodate the new signal level.
- Additional encoding requirements necessitated by the change.
  1. Locate the dip switch on the control I/O panel at the rear of the chassis.
  2. The four level bits work in a binary addition mode. Possible values range from 0 (all down) to 15 (all up). 0 is level 1 in an SC-4 control system, and 15 is level 16.
  3. Set the switches to the level you have chosen according to the following table.

Switch	1	2	4	8	Binary Value	SC-4 Level
	OFF	OFF	OFF	OFF	0	1
	ON	OFF	OFF	OFF	1	2
	OFF	ON	OFF	OFF	2	3
	ON	ON	OFF	OFF	3	4
	OFF	OFF	ON	OFF	4	5
	ON	OFF	ON	OFF	5	6
	...	...	...	...	...	...
	ON	ON	ON	ON	15	16



### Offset Switch

The offset switch allows you to provide a base offset to the router; containing inputs, outputs, or both. This applies when multiple routers are to be 'stacked' on the same level, or when multiple router frames are placed in a larger matrix.

To offset the inputs by 288 inputs, move the '1' dipswitch up. To offset the outputs by 288, move the '0' dipswitch up. The figure below displays the settings within a 576<sup>2</sup> router.

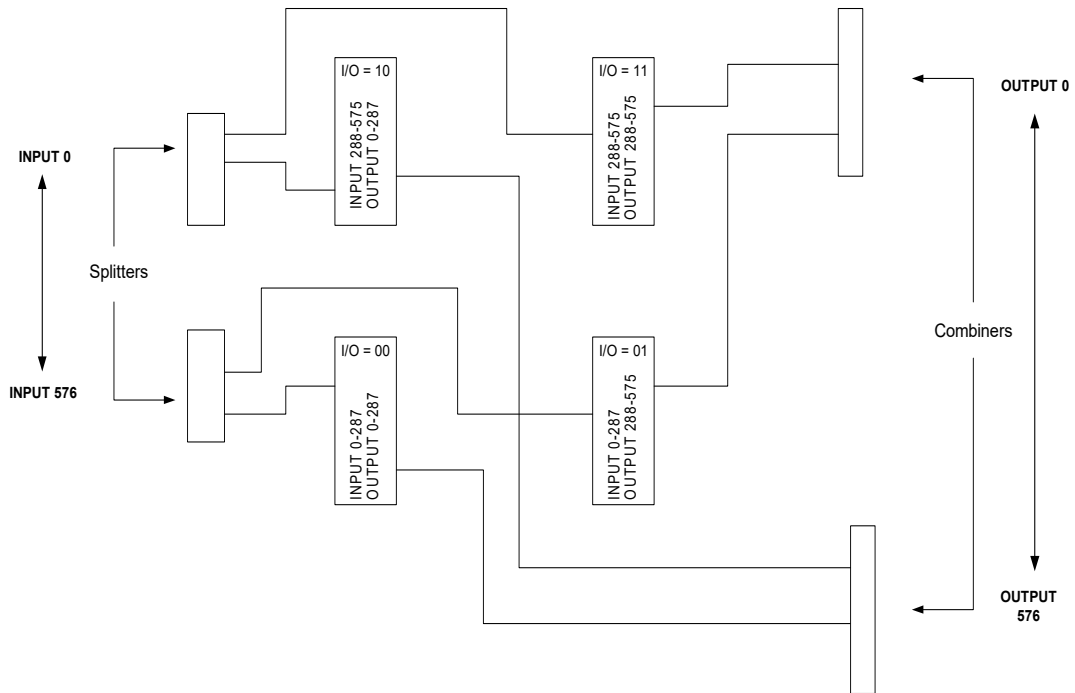

**FIGURE 2-9. Offset switch configuration**

### Installing the Video/Unbalanced Digital Audio Input & Output Signals

This section provides guidelines for installing the Utah-400 Video Inputs and Outputs on the backplane connectors. Serial Digital Video and Audio cable specifications are listed below.

Input Signal	Recommended Cable Type	Maximum Cable Length	Termination Method
Digital Video and Unbal. Digital Audio	Belden 8281	300 M. / 1000'	Internal - 75 Ohm
High Definition Digital Video	Belden 8281	100 M. / 300'	Internal - 75 Ohm
	Belden 1694A	150 M. / 500'	Internal - 75 Ohm
	Belden 7731	200 M. / 600'	Internal - 75 Ohm

The following recommendations are made regarding cable connections:

- Ensure the router frames are installed securely in the equipment racks.
- Due to the compactness of the Utah-400 rear panel BNC's, it may be useful to have a connector chart next to the backplane.
- The use of a BNC insertion / extraction tool is recommended.
- Label the Input and Output cables coming into the rear panel – for example:
  - VTR1 – Video Out or Out 0 – VTR1.
- All Utah-400 Digital Video/Unbalanced Audio BNC's use 75-Ohm single ended connectors.
- Avoid stress on the lower backplane BNC connections by providing proper strain relief on all cables.
- The Utah-400 Input matrix starts with Input 0 at the top right of the backplane.
- The Utah-400 Output matrix starts with Output 0 at the bottom right.
- Due to the 75 Ohm internal termination, do not use BNC "T" connectors to loop an input signal. This will result in serious signal degradation.

Figure 2-10 shows the entire Utah-400 288 x 288 Matrix rear panels. (Video or unbalanced digital audio.)

Figure 2-11 shows the Input rear panel connector matrix, use this matrix to connect the input cables to the chassis.

Figure 2-12 shows the Output rear panel connector matrix, use this matrix to connect the output cables to the chassis.

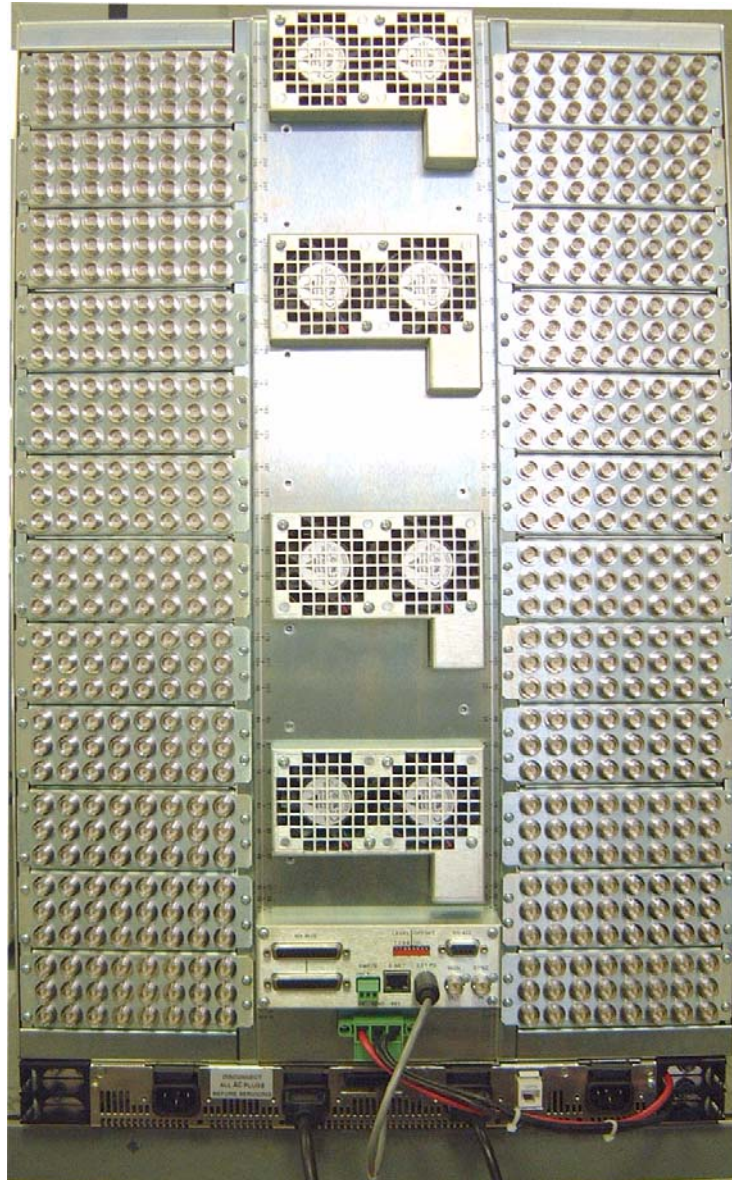

FIGURE 2-10. Utah-400 288<sup>2</sup> Video Unbalanced or Audio Rear Panels

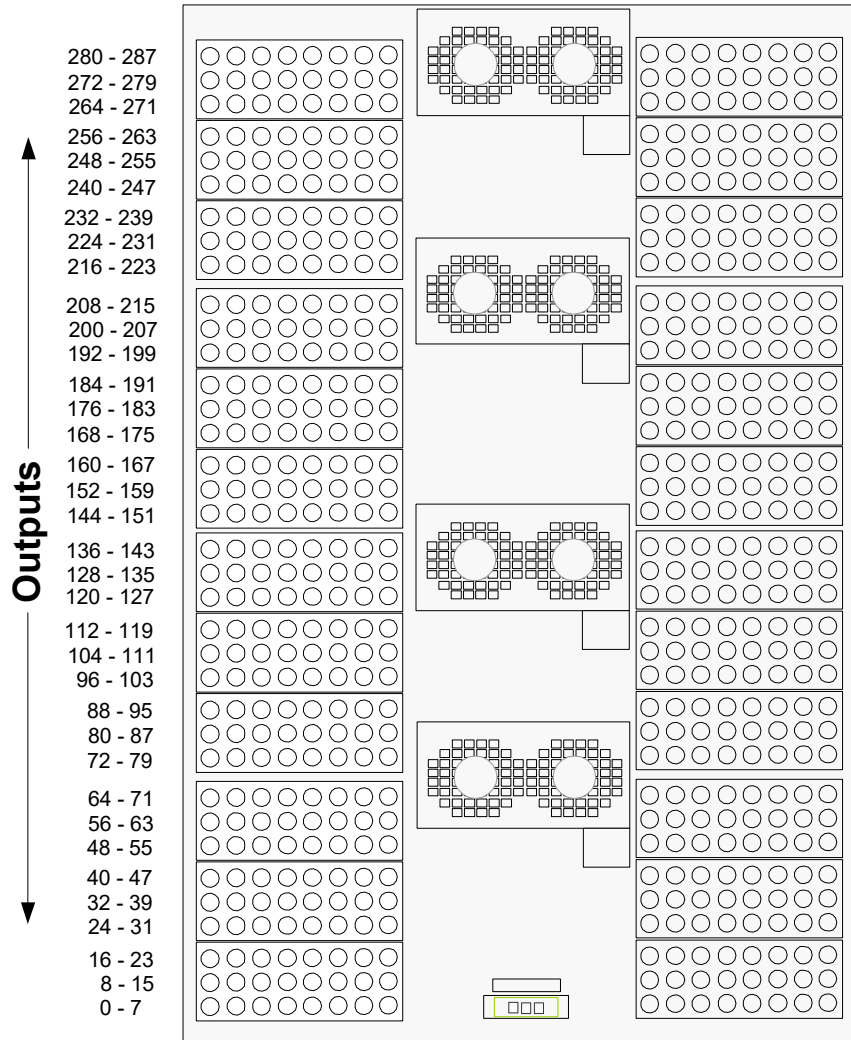

FIGURE 2-11. Unbalanced Digital Audio/Digital Video Output Connector Matrix



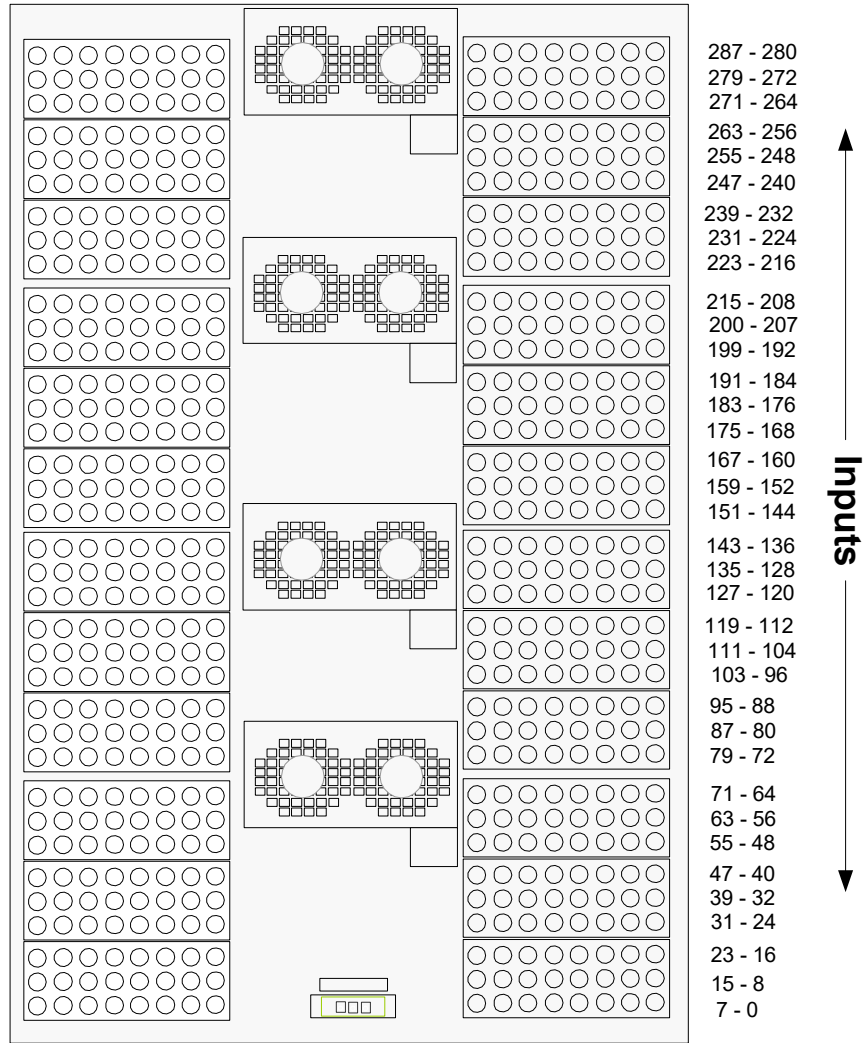

FIGURE 2-12. Unbalanced Digital Audio/Digital Video Input Connector Matrix

---

### *Installing the Analog Audio Input and Output Cables*

The following recommendations are suggested for installing the Analog Audio Inputs and Outputs.

- Ensure the Utah-400 Chassis are installed securely to the equipment rack.
- Label all cables going to the Inputs and Outputs, for example:
  - **Inputs 0-7: VTR1 – 0, VTR2 – 1, SAT –4 ...**
  - **Cable-1; Inputs 0-7, see Chart 1....**
- Pre-wired cables are available from Utah Scientific.
- D-connector to terminal block. Breakout panels are available from USI. (BDA-400)
- Inputs and Outputs can be connected directly to the backplane using 26 pin high-density "D" connectors and back shells. (Supplied with the system) Contact Utah Scientific sales for more information.
- Additional strain relief should be provided for each "D" connector, in addition to the connector screws.

Refer to Appendix A – "Hardware Specifics" for wiring charts and a list of audio connector suppliers.

Figure 2-13 illustrates an example of a Utah-400 Analog Audio Backplane. Use this figure for Input/Output connector reference.

Table 2-1 shows the connector pin-out for the 26-pin high-density connectors.

Figure 2-14 shows a blown up view of the Male 26-pin high-density connector.

Figure 2-15 shows a blown up view of the Female 26-pin high-density connector.

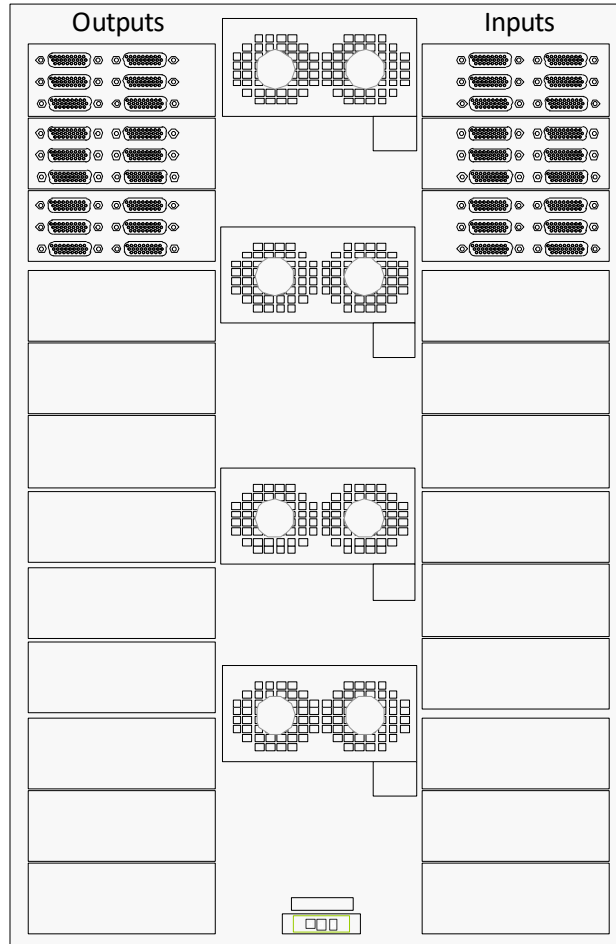

**FIGURE 2-13. Utah-400 Analog Audio Backplane**

The standard configuration for the Utah-400 Analog Audio Input and Output using DB-26 connectors (illustrated above).

The high-density DB-26 connector used on the backplane has the same wiring format for the input and outputs. Table 2-1 is a generic table and applies equally to the input and output wiring. Although any wiring scheme may be used, Utah Scientific makes the following recommendations:

- Use a high quality shielded cable for the Digital Audio. See the chart below.

<b>Recommended Cable</b>	<b>Maximum Cable Length</b>	<b>Physical Characteristics</b>	<b>Shielding</b>
Belden 9992 (or better)	100 M. / 300'	9 pair / 24 AWG / Stranded	Individual Shields and Drain wires
Belden 6387 (or better)	100 M. / 300'	9 pair / 24 AWG / Stranded	Individual Shields and Drain wires
Belden 1800A (or better)	100 M. / 300'	1 pair / 24 AWG / Stranded	Shield with Drain Wire

**Note: The cable shield should be grounded on the chassis end only; this prevents ground loops from occurring.**

- Use shrink tubing around the end of the wires and cups on the 26-pin high-density male connector when assembling. This process helps prevent any shorting between adjacent wires.
- Tie all grounds together inside the connector shell. Use an EMI Gasket for this application.

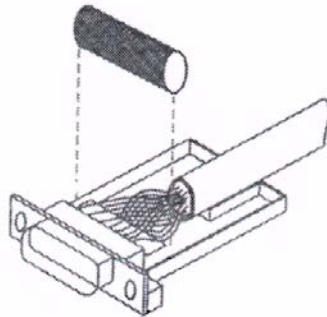

- Provide proper strain relief for the cable ends; use tie-wraps to anchor the cables as they are installed.
- Avoid running Digital Audio cables across or adjacent to AC power sources where possible.
- Do not bundle wires close to chassis backplane, this increases connector stresses.

**TABLE 2-1. Utah-400 Balanced Digital Audio/Analog Audio (Pinout Connections)**

DB-26S (Female)		DB-26S (Male)	
Pair	Pin Number	Signal	Drain Wire (GND)
1	1	Input/Output 0 +	19
	11	Input/Output 0 -	
2	2	Input/Output 1 +	20
	12	Input/Output 1 -	
3	3	Input/Output 2 +	21
	13	Input/Output 2 -	
4	4	Input/Output 3 +	22
	14	Input/Output 3 -	
5	5	Input/Output 4 +	23
	15	Input/Output 4 -	
6	6	Input/Output 5 +	24
	16	Input/Output 5 -	
7	7	Input/Output 6 +	25
	17	Input/Output 6 -	
8	8	Input/Output 7 +	26
	18	Input/Output 7 -	
N/A	9 - 10	Isolated Chassis Ground	N/A

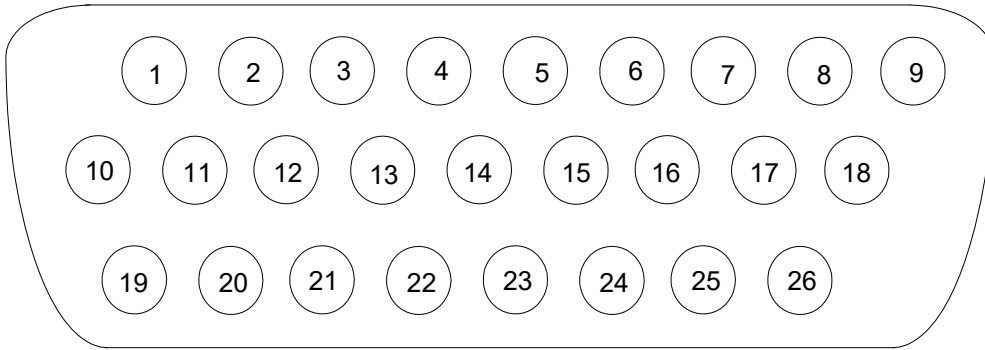

**FIGURE 2-14. DB-26 High-Density Male Connector**

---

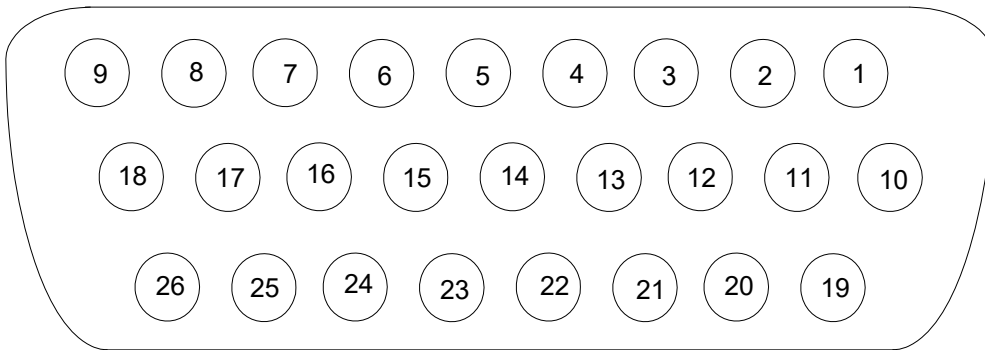

**FIGURE 2-15. DB-26 High-Density Female Connector**

---

---

### *Connecting and Disconnecting Power*

The UT-400 288R frame receives 48 volts from an external 1 rack unit power supply chassis, except in the case where it is to be supplied 48 volts directly from the facilities power distribution system. This applies to all installations where 48V reception is the requirement.

The default configuration includes two power supply modules, with two slots left blank (end slots).

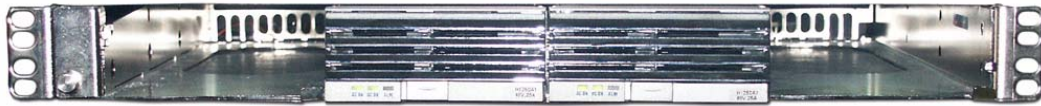

**FIGURE 2-16. Power Supply (front view)**

---

Double check the installation before applying AC power to ensure proper cable orientation.

The following diagram contains the connection detail for AC power between the power supply chassis and the router frame. (UTSCI cable assembly - **Part # 140020-0001**)



**FIGURE 2-17. Power Supply cable assembly (rear view)**

---

The cable assembly's two black wires attach the lower terminal block (on the power supply frame) to the -48V and Ground lugs on the router. The red wire attaches the upper lug (on the power supply frame) to the 0V input on the router.

## DC Connectivity

The DC input at the rear of the chassis is noticeably different than its AC counterpart. The connection consists of three separate terminals:

- Ground - Frame or chassis grounding point
- 0V - Most positive leg of -48V DC connection.
- -48V - Most negative leg of -48V DC connection.

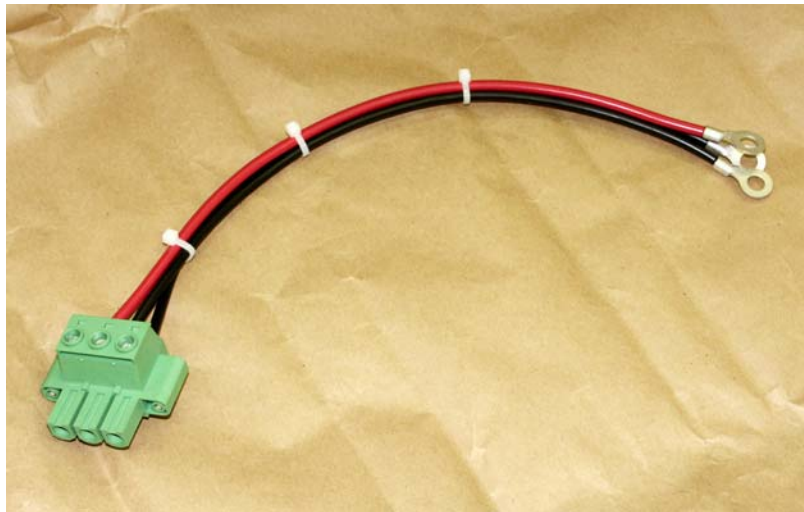

***Note that this configuration is a DC-I or DC isolated connection.***

The terminal strip is a small bracket containing three screws (see 1). Loosen the screws to remove the terminal from the back. This will expose the strip of wire (aprox. 1/4 of an inch).

### *Proper wire insertion into the removable terminal block*

- Turn the screws counter clockwise to allow wire insertion (3 screws on block top).
- Strip 1/4" of the insulation from the new wires.
- Insert wire, then turn screw clockwise to tighten

*Use 10 AWG wire (maximum)*

The maximum current required for the branch circuit feeding the UT-400 144 and UT-400 288 is 20 Amps.



---

## Pre Power-Up Checks

Before applying power to the router, check the following:

- All boards within the router must be fully seated; not crooked or outside the card guides.

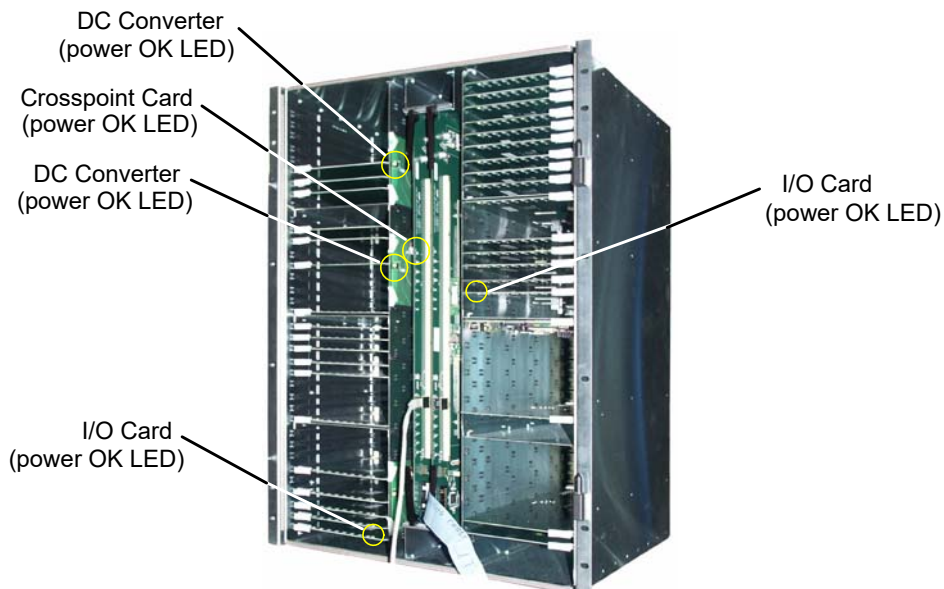

FIGURE 2-18.

---

### Initial System Power-Up

After verifying AC or DC power connections, apply power to the system. Verify that the following system indications are present.

1. All Chassis fans are turning.
2. The AC and DC power OK LEDs on the external power supply are on.
3. The four DC converter modules inside the 15 RU router frame are green.
4. The power OK LEDs on the I/O cards are on.
5. The green Power OK LEDs on the crosspoint cards (up to 2) are on.

If one or more of the indicators are not present, remove power and re-check the connections. If the problem persists, contact customer service.

## Hardware Checkout

Use the following flow chart to check out your Utah-400 System. Note the following important points:

- For the Video and Audio System columns may be switched numerically if encoding is not required.
- For the System Control column, the SC-4 Control system may require some configuration in order to perform all functions.

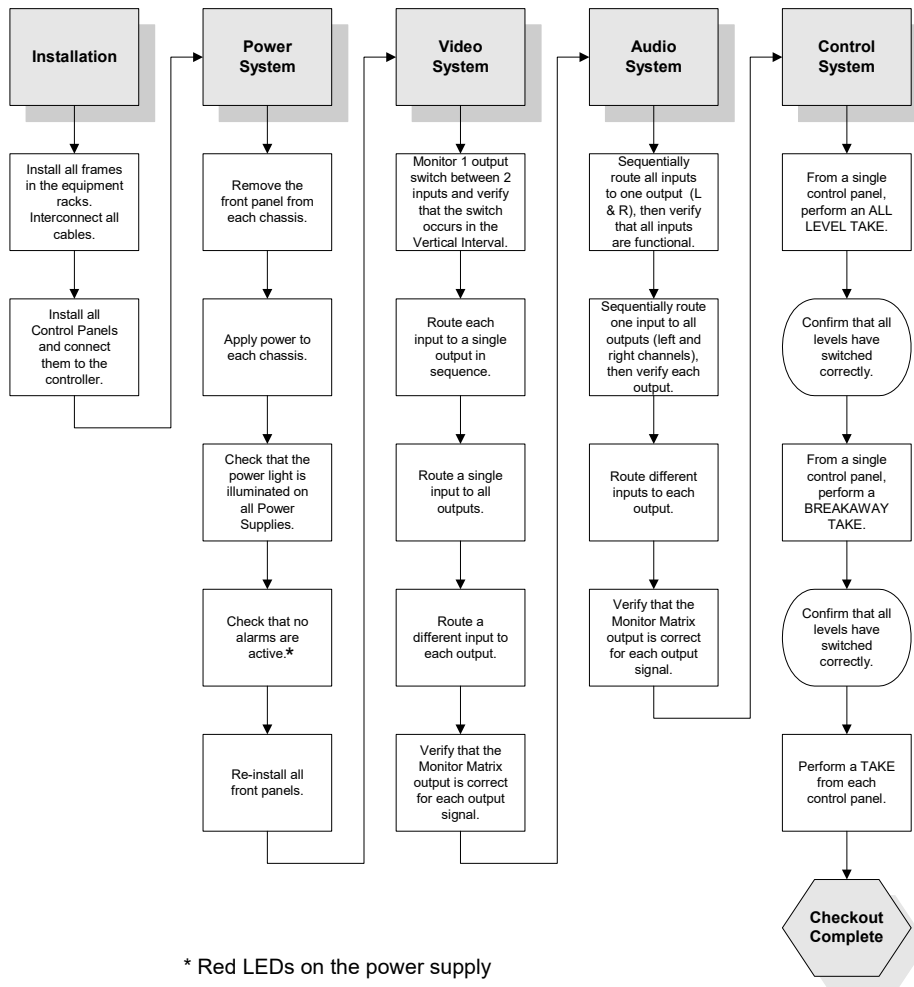

# *Configuration and Operation*

---

This chapter provides an explanation for specific Utah-400 configurations, and basic instruction for the handling and operation of your Utah-400 system.

---

## *In This Chapter*

Utah 400 SC-4 Control .....	3-2
Module Array – Panel Front .....	3-4
Operation .....	3-5
Alarm Indication .....	3-5
Ethernet and RS-422 Connection .....	3-5
Crosspoint Cards Maintenance .....	3-6
Input and Output Card Removal and Replacement .....	3-7
Crosspoint Card Removal and Replacement .....	3-7
Fan Service .....	3-8
Power Supply .....	3-9

### Utah 400 SC-4 Control

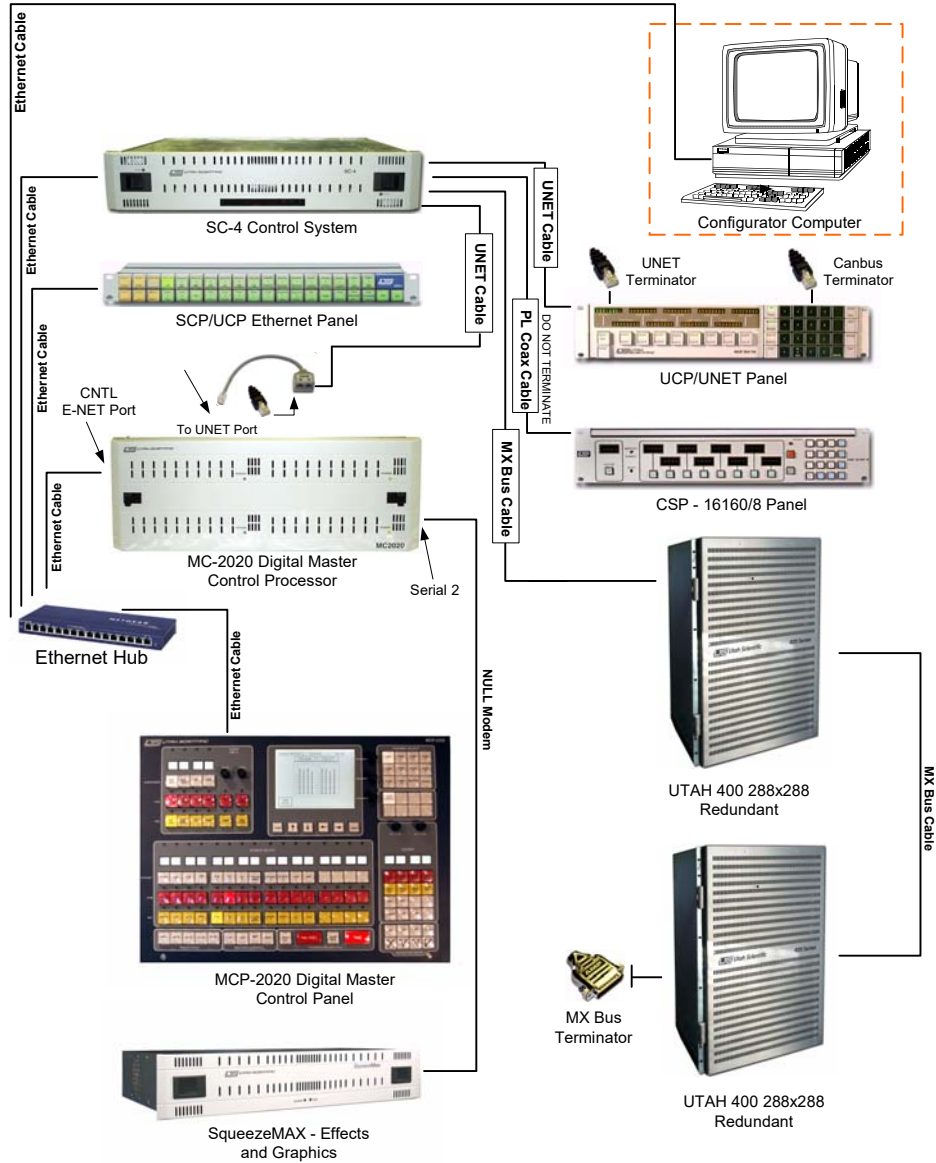

FIGURE 3-1. Utah 400 SC-4 for Utah-400 and MC/MCP-2020

TABLE 2-1. SC-4 Configuration for the Utah-400 and MC/MCP-2020

<b>SC-3/4 System Cable / Termination Table</b>			
<b>Part Name</b>	<b>Part Number</b>	<b>Description</b>	<b>Comments</b>
UNET Terminator	65324-04	8 RJ-45	Supplied by USI
MX-Bus Terminator	70797-1	DB-25P Module	Supplied by USI
MX-Bus Cable	80229-010	Parallel / DB-25P	Supplied by USI
UNET Cable	N/A	UTP/RJ-45	Not Supplied
Ethernet Cable	N/A	UTP/RJ-45	Not Supplied
Party Line Coax Cable	N/A	<b>Belden RG-59/U; 9209 or 8281</b>	Not Supplied

### *Module Array – Panel Front*

There are 36 slots containing the input modules on the router's left side. Input 0 is located at the bottom, while input 287 is at the top of the array. The outputs are placed on the right, with output 0 located at the bottom, and output 287 positioned at the top.

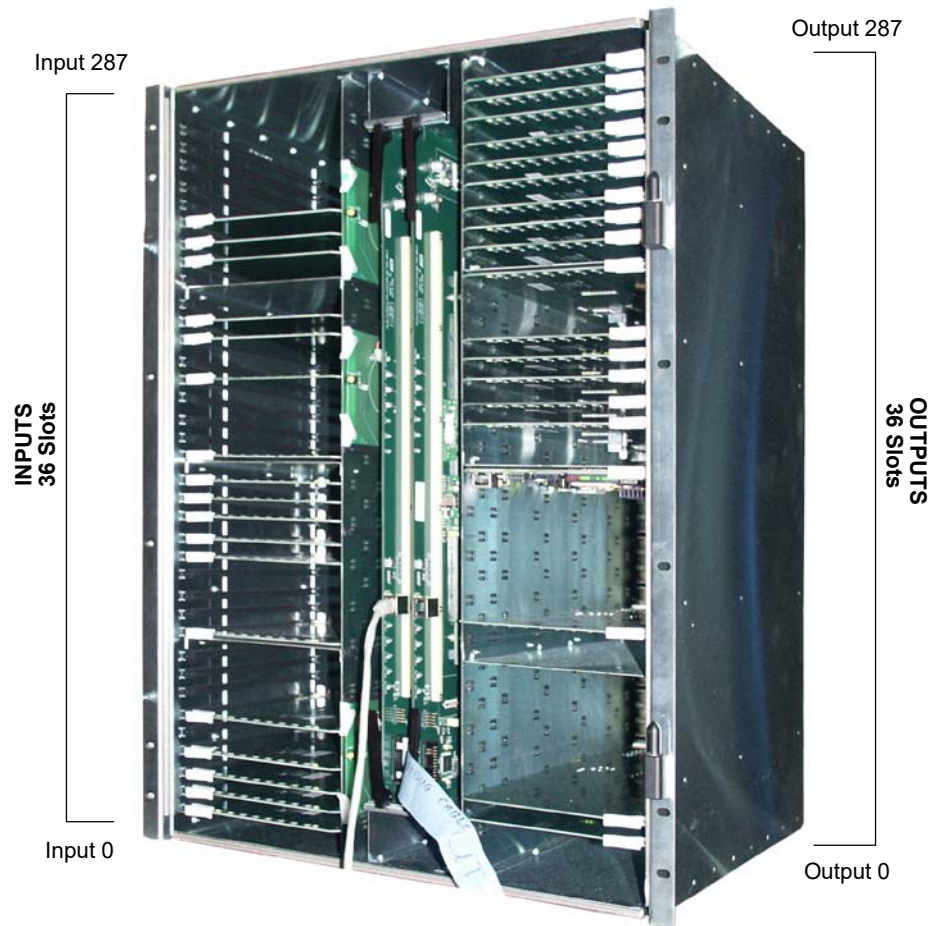

**FIGURE 3-2. Module Array**

---

---

## Operation

### Alarm Indication

The alarm LED located on the front of the UT-400 chassis is a universal indicator, and will illuminate when any alarm condition is sensed.

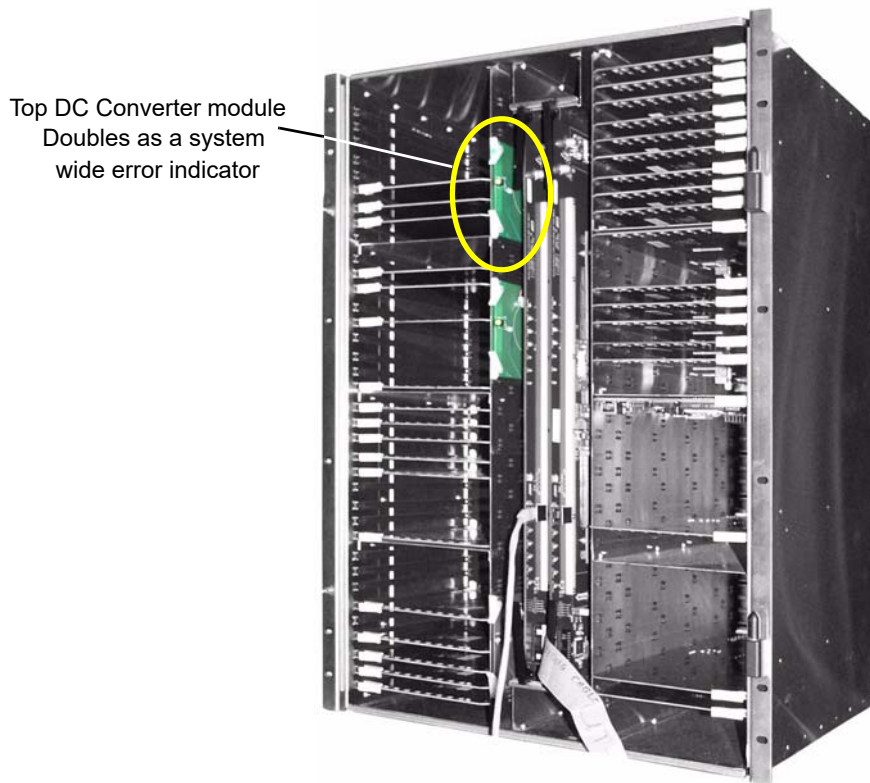

**FIGURE 3-3. Router Alarm Indication**

---

The SMPTE alarm port is used to generate contact closures indicating a problem within the system.

### Ethernet and RS-422 Connection

The Ethernet and RS-422 connections are not presently utilized on this frame.

## Crosspoint Cards Maintenance

The UT-400 chassis contains two vertical crosspoint cards at the center of the chassis; the left-most being the primary card, while the card on the right is redundant.

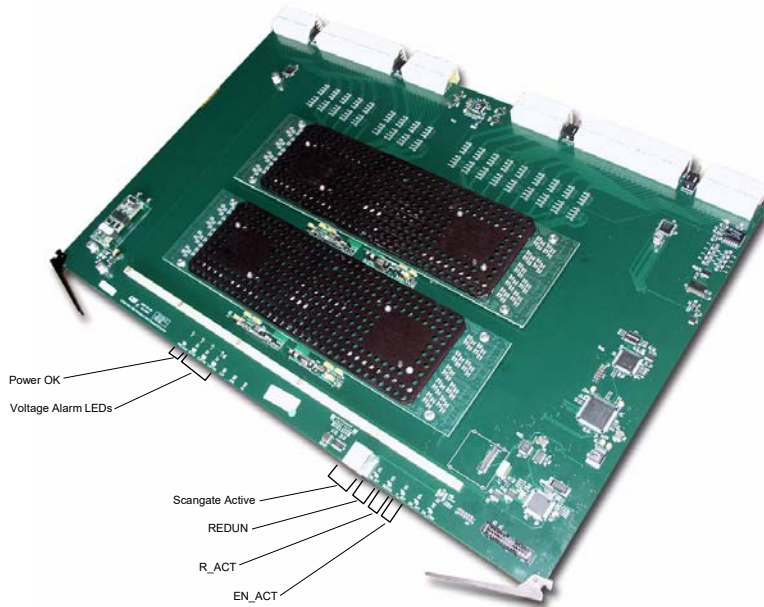

**FIGURE 3-4. Crosspoints LEDs**

The crosspoint card's voltage LEDs behave like other UT-400 series displays, with green indicating normal activity and red signaling a problem condition.

The Scangate Activity LED will flash to indicate normal activity.

The Redundant LED will be illuminated on the actual current redundant card. This card can be safely removed if necessary.

As a visual reference, the Redundant Activity LED illuminates to indicate a normal state of redundancy between the two cards.

The Ethernet Activity and Link LEDs are not in use at this time.

### *Debug Port*

The software utility associated with the crosspoint card's debug port is currently under development. Please check back.



### Input and Output Card Removal and Replacement

To correctly remove and replace the individual input and output cards, always make sure the guides are located (inside the chassis) and the card slides all the way in before the ejector is locked in place. The card ejectors are pressed inward and down from the card when locking, and pulled outward from the card when removing.



**FIGURE 3-5. Input/Output Board Replacement and Removal**

---

All boards within the Utah-400 system are hot-plug capable.

### Crosspoint Card Removal and Replacement

The Crosspoint card uses a slightly different version of the locking and unlocking mechanism. The board is removed by gently pulling the ejector tabs outward, and locked into place by pressing the two tabs inward.



**FIGURE 3-6. Crosspoint Board Replacement and Removal**

---

---

## *Fan Service*

Alarm indicators on the crosspoint control card and power supplies will indicate any fan problems.

Individual fan modules can be lifted out by removing the four screws that hold each in place. The new module is connected by simply aligning each and pushing it in place, then re-attaching the four screws.



**FIGURE 3-7. Fan location and removal**

---

## Power Supply

### *External Power Supply*

The power supply interconnects with the router at the bottom of the assembly using a cabled interface. Using Utah Scientific's pre-molded cable assembly, the ground signal and 48 volt conversion are carried to the UT-400 router. You will also see an additional cable assembly that is used for the micro controller inside the router that communicates with the alarm circuitry inside router.

The power supply module contains two redundant card pairs, which convert the 48 volts to 5 volts and 3.3 volts for the router's I/O card.

For mounting and connectivity considerations, the power supply is most appropriately located beneath the UT-400 router.

### **Crosspoint Control (Cards)**

The current crosspoint card (in use) is designated by the *absence* of the green Redundant (LED).

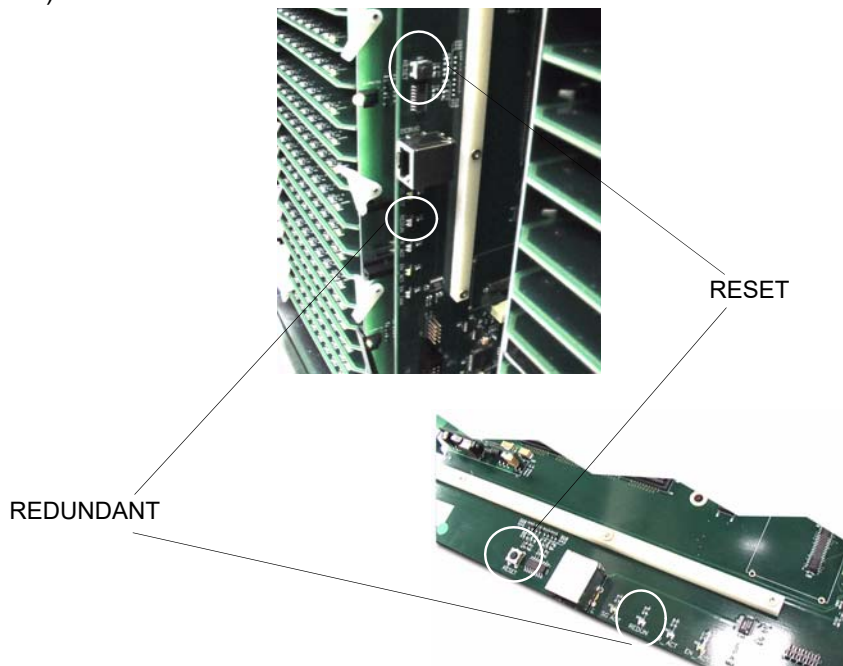

**FIGURE 3-8.**

The redundant crosspoint card is noted by the presence of the green REDUNDANT (LED), as shown in the above illustration.

By pressing the Reset button (previous figure), control is shifted to the opposite crosspoint card, with the LED pattern also changing to the alternate card.

*In This Chapter*

This chapter contains descriptions of each video and audio board type contained within the Utah-400; including Input, Output, Crosspoint and Interface (midplane) cards, and Power Supplies. Information regarding LED indications and alarms is also provided.

Video Input .....	4-2
Video Output Boards .....	4-9
Fiber Interface - (Optional) .....	4-17
Video Crosspoint Board (Redundant) .....	4-21
Rear Panel Considerations .....	4-23
Power Supplies .....	4-24
Audio Input .....	4-27
Audio Output .....	4-28
Deluxe Output Board .....	4-29
Audio Crosspoint Board .....	4-37

---

## *Video Input*

Video connectivity on the back of the router is handled through BNC or Fiber (optional). The primary connection to the outside environment occurs via the MX bus. There are two MX bus connectors, with the second one terminated if no connection is to be made to another router.

### **SD Video Input**

Part number [121016-1](#), the SD Video Input board contains 8 circuits that allow video to be received within the system. This card performs cable equalization prior to passing the signal input along to the crosspoints. This card is also limited to lower data rate Serial Digital Inputs.

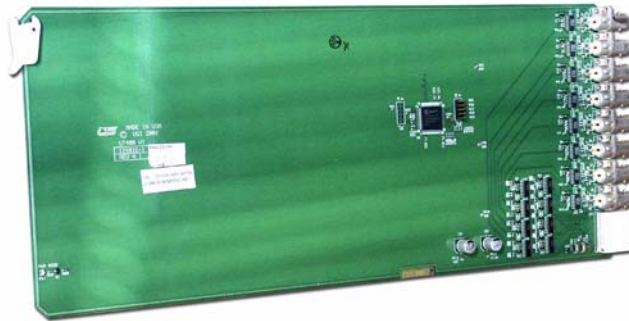

**FIGURE 4-1. SD Video Input Board**

---

### Multi-Rate Input

Part number [121020-1](#), the Multi-Rate Input board is designed for High Definition Inputs, as well as Serial Digital Inputs.

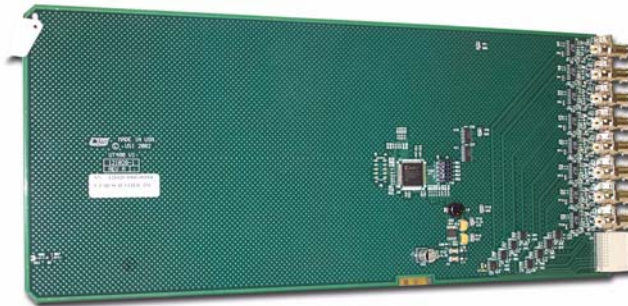

FIGURE 4-2. Multi-Rate Input Board

---

### Analog to Digital

Part number [121045-1](#), the Analog to Digital board allows the input of analog video signals, then takes these signals and converts them to digital before presenting them to the Crosspoint card(s).

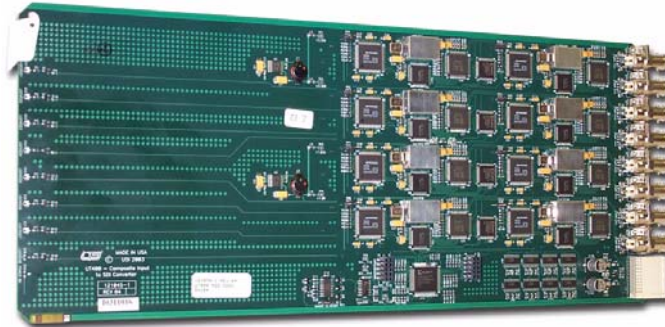

FIGURE 4-3. Analog to Digital Board

---

*LED Indications*

The SD Video Input and Multi-Rate Input cards only contain a 'Power Good' indication. This LED responds to the Utah-400's two power supplies and illuminates if power is okay, and is not lit when power is absent.



**FIGURE 4-4. Power Good LED**

---



---

**Video Input**

---

The Analog to Digital board contains the same Power Good indication as above, and also contains an LED for each input signal – green if the signal is present, and not illuminated to indicate signal absence.

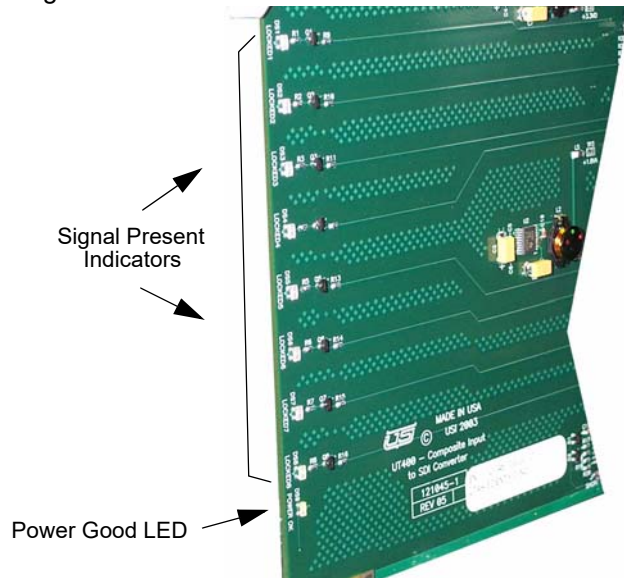
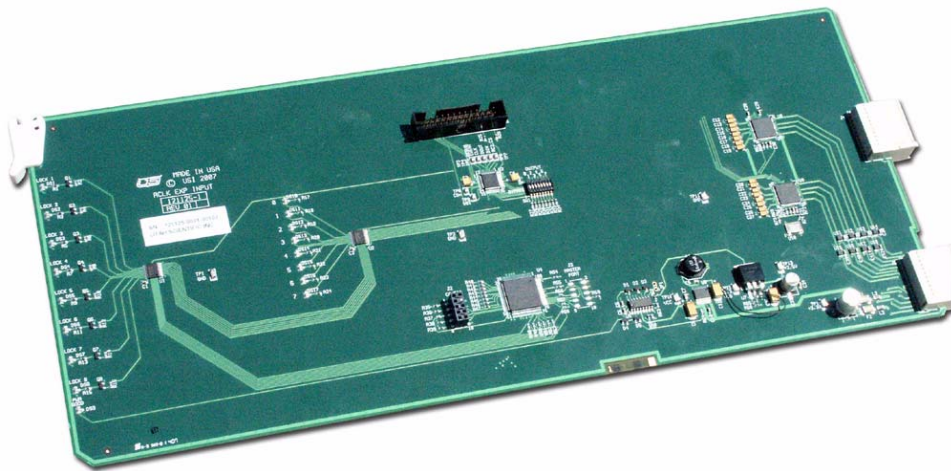

**FIGURE 4-5. Analog to Digital card LEDs**

---

### Reclocking Input Expansion Card

Part #121125-1, the Reclocking Input Expansion card is used only in the output expansion stacks of the UTAH-400 1152x1152 series of routers. Instead of accepting serial digital or analog signals from rear panel mounted BNC connectors, [they] accept signals from the first output stack (0-287 outputs) through a custom 8-way interconnect cable. The card can process SD-SDI or HD-SDI signals, or analog signals that have been converted to SD-SDI in the first frame.



**FIGURE 4-6. Reclocking Input Expansion card**

---

#### *Features*

This card handles 8 channels of video; it receives, equalizes, and reclocks the video signals coming from the first frame, then distributes them to both the local frame's crosspoint and the midplane expansion output connector. This allows for a connection to another UTAH-400 output chassis stack. The card also has the ability to disable reclocking on individual inputs if desired, and contains an array of status LED's to indicate whether or not it has locked to a signal, and if so, that signal's rate.

#### *Controls*

The single control point on this card is dipswitch SW1, the bypass control. By moving one of the individual switches to the 'ON' position, the reclocker for that input is defeated. The dipswitch labeled 0 is for the lowest numbered input on the card, while 7 corresponds to the highest.

### *Indicators*

There are 17 LED's located on the card, 8 correspond to the input signal lock status, 8 correspond to a rate indication, and one is a board power good indicator. DS9 is the power good indicator, and when lit, board power supplies are OK. If not lit, one or more of the supplies on the board have failed.

DS1-8 are locked indicators for the 8 inputs on the board. DS1 corresponds to the lowest input number, while DS8 corresponds to the highest. ON indicates that this particular input is present and is being reclocked. A dark LED means the signal is not present. Please note that if the reclocker is bypassed, the corresponding LED will be dark.

DS10-17 - (text to follow)

### Specifications

Power Consumption - 4.25W

Reclocker Rates - SMPTE-259CD and SMPTE 292. The card must be manually bypassed for any other rates.

### **UTAH-400 3G Input Card**

Part #121170-1 the UTAH-400 3G Input card contains 8 inputs that accept SDI signals. There are two versions of this card; identified by a -1 or a -2 in the serial number. The -2 version is capable of receiving all SDI signals up to the SMPTE-424 1080P standard. The -1 version contains a maximum data rate of HD-SDI, the SMPTE-292 standard.

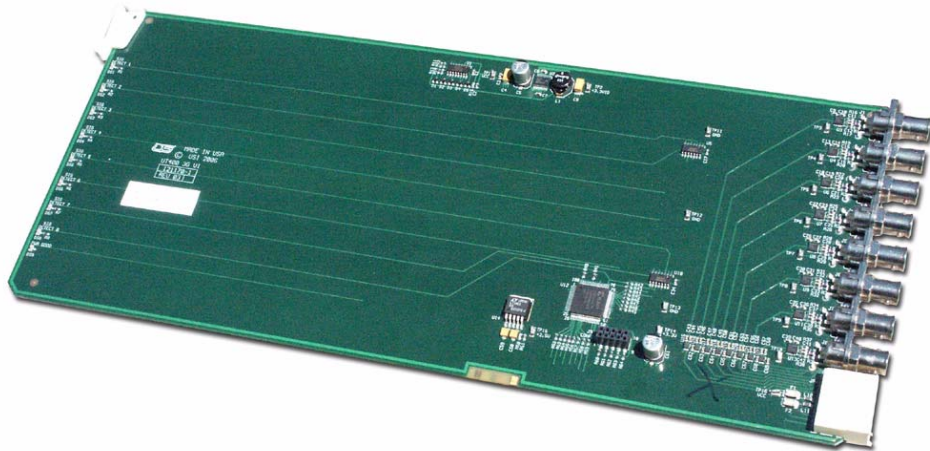

**FIGURE 4-7. 3 Gig Input card**

---

### *Features*

The card handles 8 channels of video; receiving and equalizing the video signals coming from the 8 rear panel mounted BNC connectors, then distributing them to both the local crosspoint (in the frame) and to the midplane expansion output connector, allowing for connections to an additional UTAH-400 output chassis stack. The card also contains an array of status LED's to indicate if it has acquired the carrier of a SDI signal.

### *Controls*

None

### *Indicators*

There are 9 LED's located on the card; 8 used for input signal carrier status, and one used for the 'power good' indication.

DS9 is the power good indicator, and when lit, all board power supplies are OK. When not lit, one or more of the supplies on the board have failed.

DS1-8 are carrier indicators for the 8 inputs on the board. DS1 corresponds to the lowest input number, while DS8 corresponds to the highest. ON indicates that this particular input is present. A *dark* LED means the signal is not present.

### *Specifications*

Power Consumption - 3W

Cable EQ Capability

**TABLE 1.**

SD-SDI SMPTE259	350 Meters of 1694 Cable
HD-SDI SMPTE-292	140 Meters of 1694 Cable (-2 version) 200 meters (-1 version)
3G SDI SMPTE 424	120 Meters of 1694 Cable

---

## *Video Output Boards*

The Utah-400's Video Output cards receive signals from the Crosspoint card, where user specified switching takes place. All three card types (below) perform a signal presence detection, while the SD and HD Output cards contain a re-clocking stage.

### **SD-Output**

Part number 121015-1, this card is used only for data rates that are within the standard definition range – up to approximately 540MHz per second. The SD output card is capable of passing 5 specific SMPTE data rates, with any other signal muted. This card will not pass non-standard video signals.

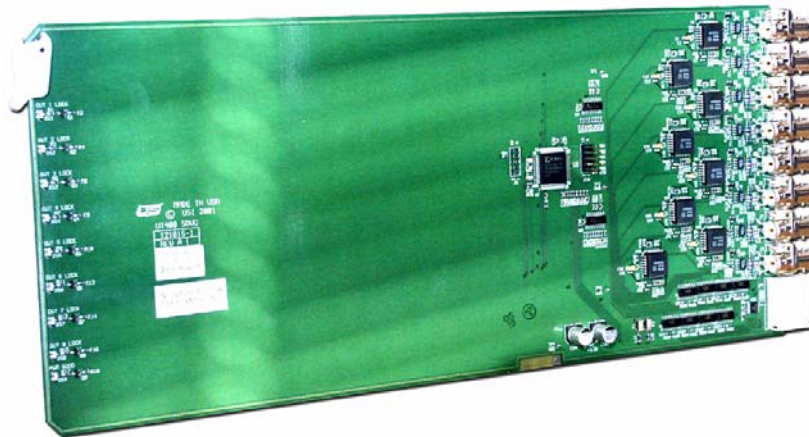
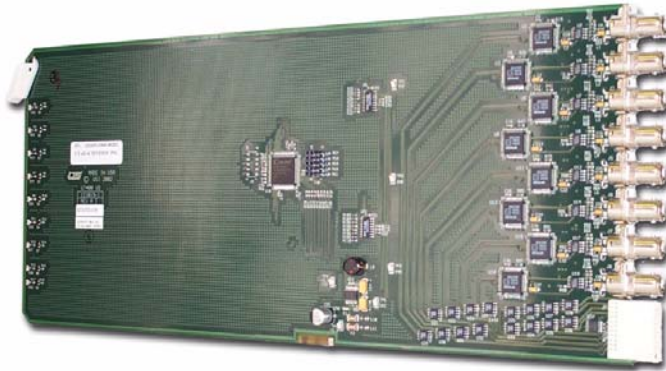

**FIGURE 4-8. SD Output Board**

---

### HD-Output (Multi-Rate output card)

Part number 121019-2, the HD-Output card is capable of re-clocking at all SD and high-definition frequencies. Though non-standard video signals will not be re-clocked by this card, these signal types will be passed without muting.



**FIGURE 4-9. Multi-Rate Output Board**

---

This board contains 1 dipswitch (per channel). The dipswitch will enable or disable the re-clocking mechanism.

### Digital Video to Analog Converter Output card

Part number 121046-1, the Digital Video to Analog Converter card takes a standard 270 Megabit serial digital signal, then converts it to analog video before presenting it to the output.

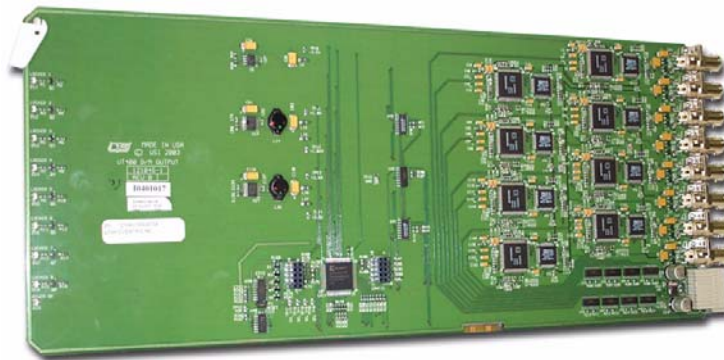

**FIGURE 4-10. Digital to Analog Output Card**

---

*LED Indications*

The Video cards contain a 'Power Good' indication. This LED responds to the Utah-400's two power supplies and illuminates if power is okay, and is not lit when power is absent.



**FIGURE 4-11. Video Output Power Good LED**

---

The SD/HD Video Output cards and the Digital to Analog card contain a Power Good indication, and also contain an LED for each output signal – green if the signal is present, and not illuminated to indicate signal absence.

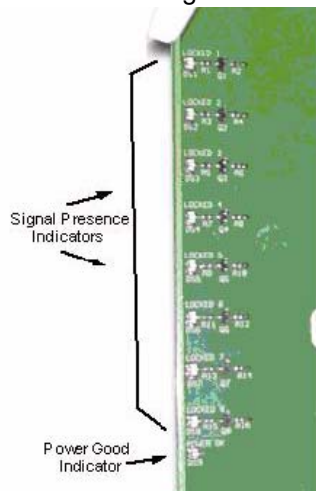

**FIGURE 4-12. SD/HD Video Output and Digital Video to Analog LED Indicators**

---

## **Multi-Rate Output Board**

### *Overview*

The Multi-Rate output card is capable of passing signals from between 3 Mb/Sec. to 1.5Gb per second. This card contains all of the features of earlier UT400 output cards at a lower cost and power consumption, with also some enhanced diagnostic and control facilities. This card occupies a single 8-output slot in a UT-400 64, 144, or 288 system.

### *Status Description*

There are three sets of diagnostic LED's on the Multi-Rate Output card.

- First, DS9 (Power OK) is a very simple indication that both on-board power supplies are running.
- Second, DS1-DS8 are indications that the re-clocker chip has an active lock on the signal a particular channel is passing. These LED's will be off when either there is no signal passing through a given output or that channel has been manually bypassed.



---

**Video Output Boards**

---

- Thirdly, DS17-DS10 represent a status array that indicates what data rate the re-clocker (if locked) is actually locked to.
  - DS15-DS17 represent a three bit indication of the output number. The following table indicates the state of these LED's for the various outputs.

Output	DS15	DS16	DS17
0	OFF	OFF	OFF
1	OFF	OFF	ON
2	OFF	ON	OFF
3	OFF	ON	ON
4	ON	OFF	OFF
5	ON	OFF	ON
6	ON	ON	OFF
7	ON	ON	ON

DS10-DS12 represent a 3-bit data rate indication

Rate	DS10	DS11	DS12
None	OFF	OFF	OFF
270 Mb/S	OFF	ON	OFF
360 Mb/S	OFF	ON	ON
540 Mb/S	ON	OFF	OFF
1.5 Gb/S	ON	OFF	ON
2.97 Gb/S	ON	ON	OFF

These LEDs change at about a 1 second rate, giving you status of all of the re-clockers in about seven seconds.

If the onboard MPU cannot access the re-clocker chips to control them, DS10-DS17 will be set in a '55' pattern to indicate a communication problem.

### **Control Description**

The Multi-Rate card has a single dipswitch, SW1, which enables or disables each of the 8 reclockers. When the dipswitch for a given output is set to the 'Reclock' position, the re-clocker will continually hunt for one of the following rates -- 270 Mb/Sec. (SMPTE 259M), 360 Mb/Sec. (SMPTE 259 Wide Screen), 540 Mb/Sec. (SMPTE 344) or 1.485 Gb/Sec. (SMPTE292). When it finds one of these data rates, it will lock to it and re-time the data to reduce jitter. If it loses lock, it will continue the process of hunting for the next data rate.

If the switch is set to 'Bypass', the re-clocker will not re-time the data, it will simply pass it from it's input to it's output. This is the preferred setting for any rate other than one of the ones listed above.

### UTAH-400 3G Output Board

Part # 121171-1, the eight output, 3G Output Board can reside in any model of UTAH-400 router and is capable of reclocking and transmitting SDI signals. It comes in two different versions; the 121171-2, which covers data rates from SMTE-259, 292, and 424, and the 121171-1 version that covers data rates for SMPTE 259 and 292. The version of the card is determined by the -1 or -2 on the serial number sticker.

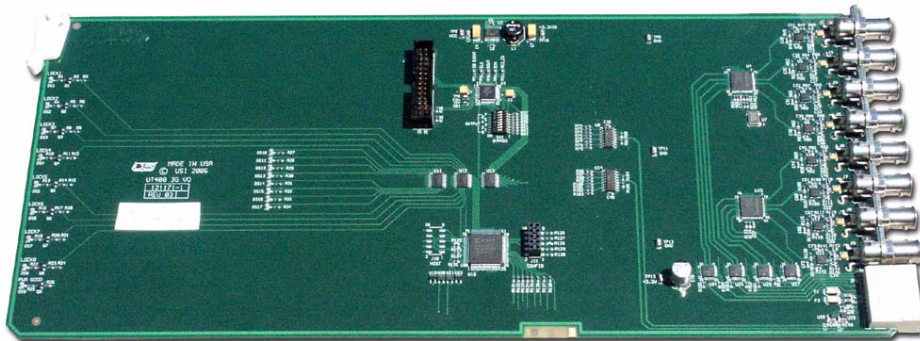

FIGURE 4-13.

---

#### *Features*

Handling eight channels of video, the card receives, equalizes, and reclocks the video signals coming from the local crosspoint card. These signals are then directed to a monitor matrix via the rear panel mounted BNC's. The card has the ability to disable reclocking on individual outputs if desired, and also contains an array of status LED's to indicate a signal lock, and if present, that signal's rate.

#### *Controls*

The single control point on this card is dipswitch SW1, the bypass control. By moving one of the individual switches to the 'ON' position, the reclocker for that input is defeated. The dipswitch labeled 0 corresponds to the lowest numbered input on the card, while 7 corresponds to the highest.

#### *Indicators*

There are 17 LEDs located on the card; 8 are designated to input lock status, 8 are designated for a rate indication, and 1 is a board power good indicator.

DS9 is the power good indicator. When lit, board power supplies on the board are OK. If this indicator is not lit, one or more of the supplies on the board have failed.

DS1-8 are locked indicators for the 8 outputs on the board. DS1 corresponds to the lowest output number, while DS8 corresponds to the highest. ON indicates that this particular output is present and is being reclocked. A dark LED means the signal is not present. Please note that if the reclocker is bypassed, the corresponding LED will be dark.

DS10-17 (information to follow)

### *Specifications*

Power Consumption - 6.5W

Reclocker Rates - SMPTE-259CD, SMPTE 292 and SMPTE-424 ( -1 Version Only). Card must be manually bypassed for any other rates.

*Fiber Interface - (Optional)*

Utah 400 systems with fiber connectivity will contain dedicated input and output boards for this purpose. Instead of using BNCs for the physical connection, the system utilizes small modules that plug directly into the rear of the UT-400 chassis.

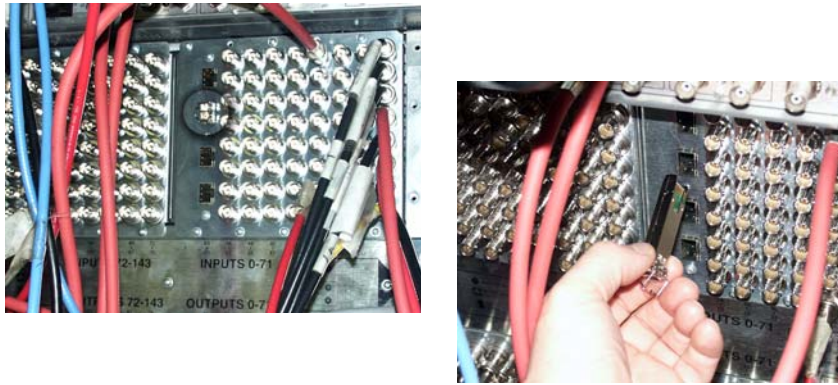

**FIGURE 4-14. Module location and removal**

The Input and Output board's LEDs are identical in functionality to their Multi-Rate Input and Output counterparts. (For more detail, see Fiber LED Indications - 4-13.)

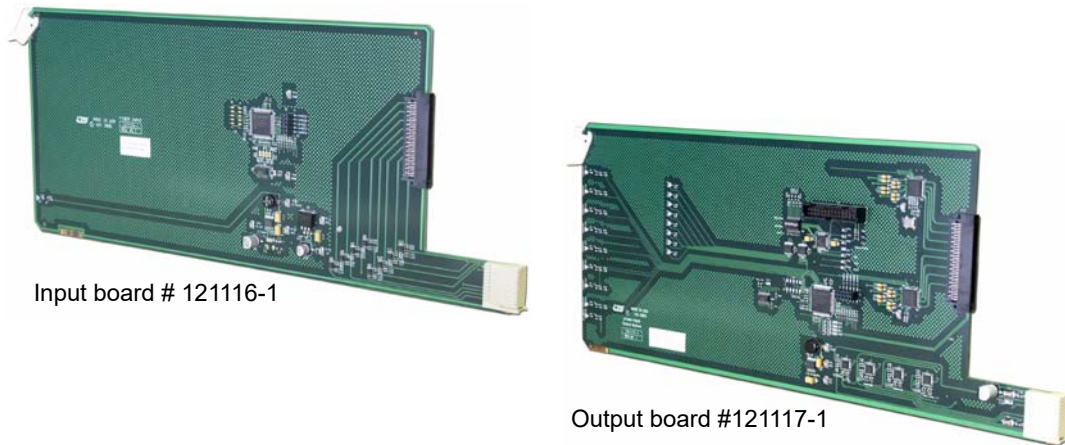

**FIGURE 4-15. Input and Output boards**

The small modules are responsible for the electrical-optical conversion, and are removable if service is required.



**FIGURE 4-16. SP2T - Transmitter module**

---

The SP2R is the receiver module, and is a part of the larger Input card assembly. The SP2T is the transmitter module, and makes up the Output card assembly. These modules are removed and replaced by moving the swinging bale (at the end) out of, and back in to the locked position.

The system's input and output *totals* are typically defined prior to equipment setup and operation. This is based on the number of total fiber inputs.

### Specification Detail

- Optical Fiber Output – 1310 nm class 1 laser.
- Optical Output Power - -12dB minimum
- Optical Fiber Type – 9/125 uM Single Mode Fiber
- Connector Type - LC
- Typical Cable Length – 18 Miles SD, 10 Miles HD
- Optical Fiber Input – 1310 nm Class1 laser
- Optical Input Power - -20dB min
- Optical Fiber Type – 9/125 uM Single Mode Fiber
- Connector Type - LC
- Typical Cable Length – 18 Miles SD, 10 Miles HD

### Fiber Output LED Indications

There are three sets of diagnostic LED's on the Multi-Rate Output card.

- First, DS9 (Power OK) is a very simple indication that both on-board power supplies are running.
- Second, DS1-DS8 are indications that the re-clocker chip has an active lock on the signal a particular channel is passing. These LED's will be off when either there is no signal passing through a given output or that channel has been manually bypassed.
- Thirdly, DS17-DS10 represent a status array that indicates what data rate the re-clocker (if locked) is actually locked to.
  - DS15-DS17 represent a three bit indication of the output number. The following table indicates the state of these LED's for the various outputs.

Output	DS15	DS16	DS17
0	OFF	OFF	OFF
1	OFF	OFF	ON
2	OFF	ON	OFF
3	OFF	ON	ON
4	ON	OFF	OFF
5	ON	OFF	ON
6	ON	ON	OFF
7	ON	ON	ON

DS10-DS12 represent a 3-bit data rate indication

Rate	DS10	DS11	DS12
None	OFF	OFF	OFF
270 Mb/S	OFF	ON	OFF
360 Mb/S	OFF	ON	ON
540 Mb/S	ON	OFF	OFF
1.5 Gb/S	ON	OFF	ON

These LEDs change at about a 1 second rate, giving you status of all of the re-clockers in about seven seconds.

If the onboard MPU cannot access the re-clocker chips to control them, DS10-DS17 will be set in a '55' pattern to indicate a communication problem.



---

*Video Crosspoint Board (Redundant)*

Part number 121174-1, the Redundant Video Crosspoint board contains 288 inputs and 288 outputs with a crossbar array in the middle. The Crosspoint board receives signals through the midplane from the 36 input cards, while switching is carried out by a single crosspoint chip located underneath the heat sink. After the signal is switched, it is again routed through the midplane to the output boards.

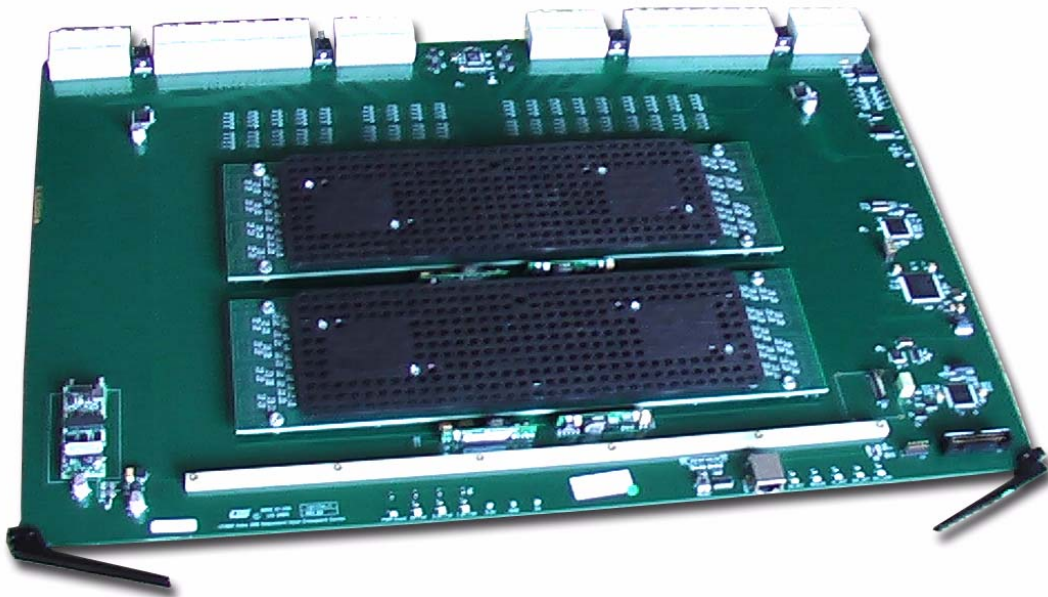

FIGURE 4-17. Video Crosspoint Board (Redundant)

---

**Indicators**

*Power Ok LED*

The green LED is illuminated when all supplies are normal and functioning.

*Voltage Failure Mode (3 LEDs)*

In this mode, one of the red LEDs will illuminate while the green 'normal' LED turn off.

*Scan Data Active (LED)*

The yellow LED pulses continuously when conditions are normal. A solid LED indicates the 'standby' crosspoint in a redundant system.

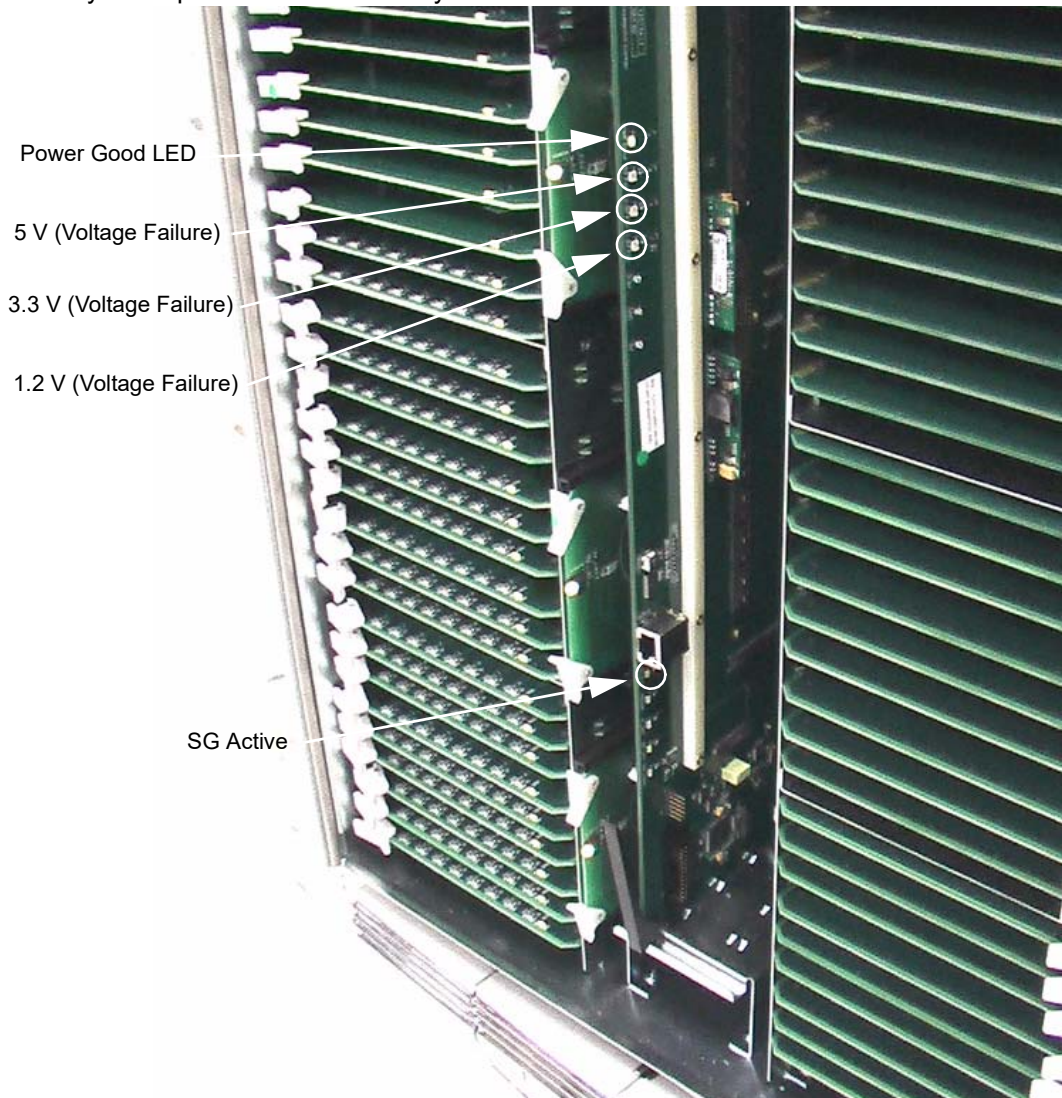

**FIGURE 4-18. Video Crosspoint LEDs**

---

*Rear Panel Considerations*



FIGURE 4-19.

**MX Bus**

This is the control bus between the UT-400 and an SC-3/4 controller. Each chassis contains two connectors, fed through either side, then distributed to the next piece of equipment from either side.

If this router is at the end of the run (cable), a termination is inserted at the unused side.

**Dip Switches**

The dip switches are used to set the location of the router within the MX-Bus system. Usage example: A first level, binary setting would require all switches to be placed in the down position.

**Monitor Output**

This provides the signal for the monitor bus as it exits the router.

## **Analog Blackburst**

This is utilized as a reference for the BNC card's analog video output.

---

## *Power Supplies*

### *External Power Supply*

The additional power supply assembly is a 1 rack unit chassis fed by AC, converting the signal to 48 volts DC.



**FIGURE 4-20. External Power Supply**

---

The power supply interconnects with the router at the bottom of the assembly using a cabled interface. Using Utah Scientific's pre-molded cable assembly, the ground signal and 48 volt conversion are carried to the UT-400 router.

The power supply module contains two redundant card pairs, which convert the 48 volts to 5 volts and 3.3 volts for the router's I/O card.

For mounting and connectivity considerations, the power supply is most appropriately located beneath the UT-400 router.

---

## Power Supplies

---

The unique cable assembly allows the micro controller to efficiently communicate, sending accurate alarm signals any time an issue arises.



**FIGURE 4-21. Cable Assembly**

---

### *Router Power Supplies*

The Utah-400's power supplies are standard, with AC input, alarm monitoring circuitry, and DC output going to the system.

### **LED Indications**

If no alarms are present, the ALM LED will be off while the yellow LEDs (AC OK and DC OK) will be illuminated.

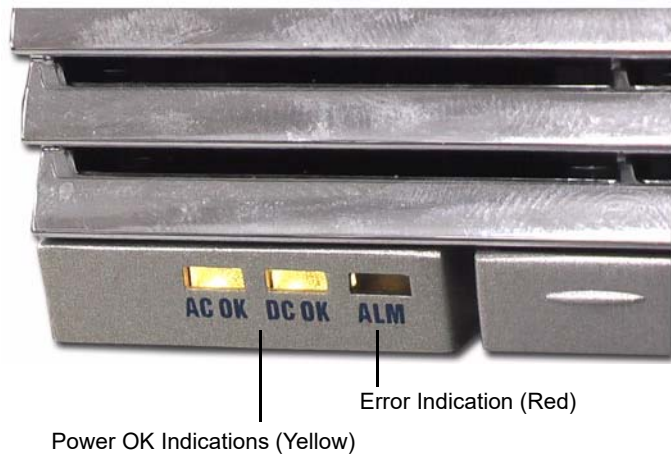

**FIGURE 4-22. Power Supply**

---



Individual supply alarms will be indicated with the corresponding red LED. Specific adjustments are available for individual voltage indications within this guide's Troubleshooting section.

The LED is viewable on the front cover through the lightpipe.

---

## *Audio Input*

### **Audio Input Board**

Part number 121026-1, the Audio Input board contains 8 circuits that allow audio to be received within the system. This card contains 8 LED indicators, which correspond to the 8 individual input channels that the card processes. The 9th LED indicator is used for local power monitoring, while the 10th indicator (Program Done) illuminates when a download has properly occurred.

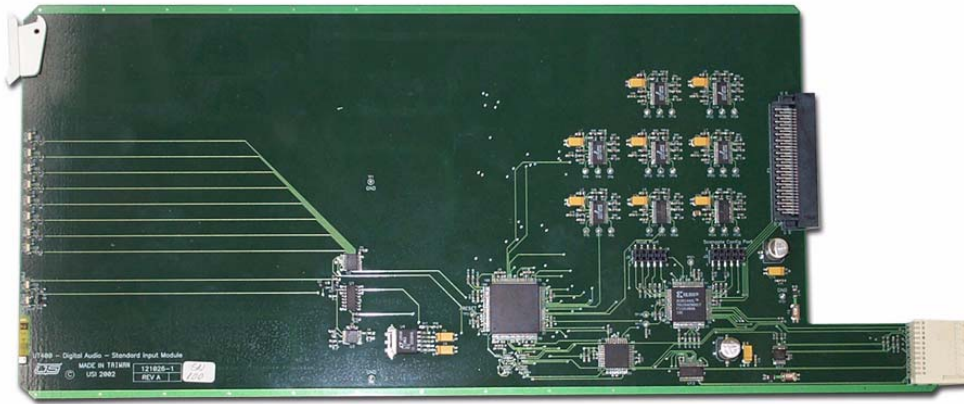

**FIGURE 4-23. Audio Input Card**

---

---

## *Audio Output*

### **Audio Output Board**

Part number 121027-1, the Audio Output board contains 8 circuits that allow audio to be distributed to the backplane. This card contains 9 LED indicators, 8 of which correspond to channel activity. The 9th LED indicator (offset from the others) is the board's Power OK indicator.

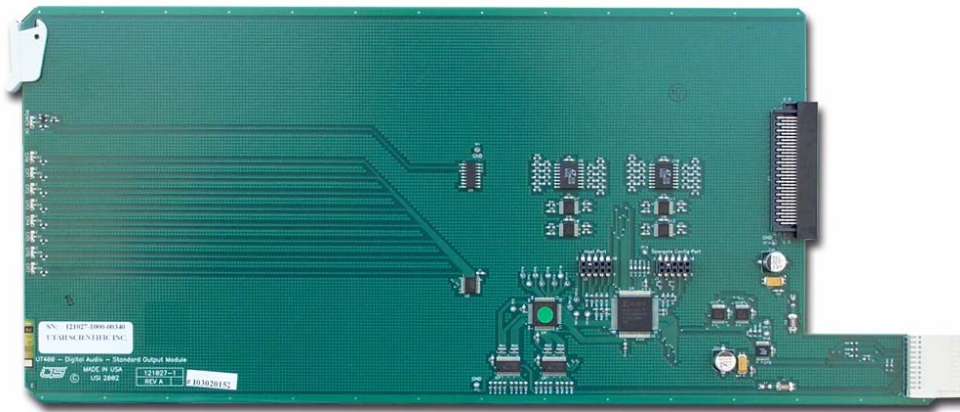

**FIGURE 4-24. Audio Output Card**

---

Two configurations for this card are available; one for balanced operation (part number 121028-1), and one for unbalanced standard operation (part number 121029-2).



---

*Deluxe Output Board*

This card is capable of performing Audio Fades, typically as switching is done from one source to another.

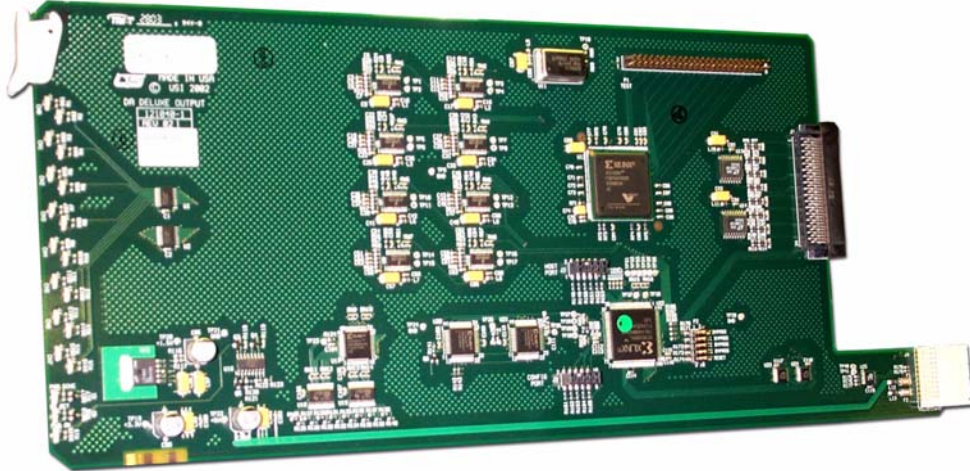

**FIGURE 4-25. Deluxe Audio Output Card**

---

Accomplished during the switch, the audio fade feature suppresses any pops or clicks that may potentially be present if the fade did not occur.

This card contains a larger array of input indicators; with two associated with each of the 8 channels processed on the board.

## Board Indicators

There are two indicators per channel; green to indicate signal presence, and red to indicate any defect in the signal. A defect typically exists when certain signal formats are non-standard.

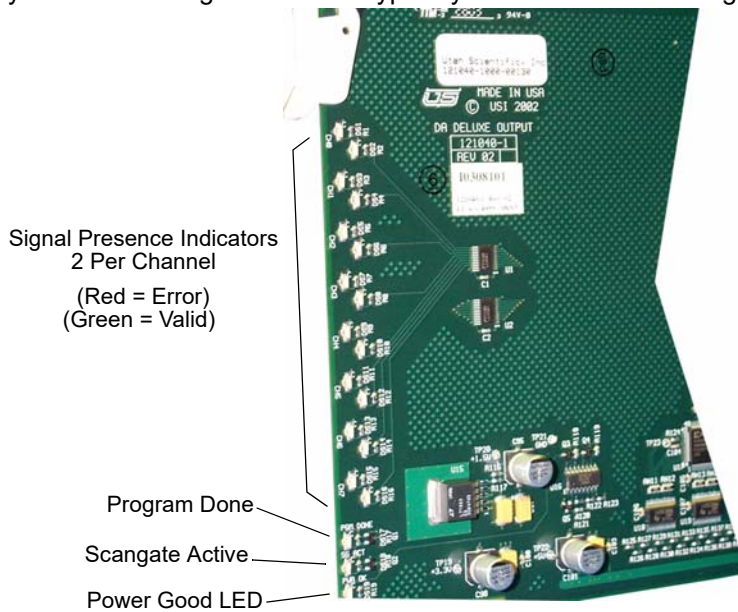

**FIGURE 4-26. Deluxe Audio Output Card**

---

The Deluxe output card contains a Power Ok indication, and a Program Done indication.

The SGACT (Scangate Active) LED indicates a successful communication between the host processor on the crosspoint board and the actual output board. The Program Done and Power LEDs should be on, while the Scangate Active LED flashes continuously.

The Deluxe Output board mates up with the same I/O adaptors as the standard card, allowing the mixing of different balanced or unbalanced cards within the same chassis.

### Deluxe Output Module

This circuit module, USI 121040-1, is an alternate output module for the Utah-400 digital audio router with capability to modify the payloads of the eight AES-formatted digital audio signals that it conveys.

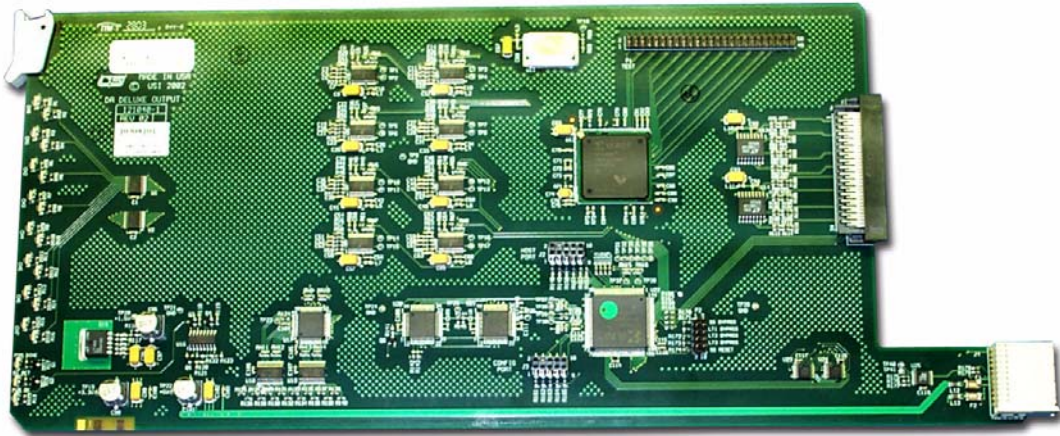

FIGURE 4-27. Deluxe Output Module

---

These capabilities include the following:

- Execution of a V-fade that ensures clickless synchronous switching of outputs by first fading-down the previous source from full to zero amplitude, performing a synchronous source switch, then fading-up the new source from zero to full amplitude.
- Execution of analog-like channel data manipulations:
  - Channel swap
  - Channel 1 to both output channels
  - Channel 2 to both output channels
  - Selective polarity (phase) inversion of channels
  - Selective muting of channels
  - Summation of channels to monaural ([L+R],  $-[L+R]$ )
  - Summation of channels to difference signals ([L-R], [R-L])
- Adjustment of output word lengths to 16, 20, or 24 bits at user discretion.

Addition of dither to output signals at user discretion.

These capabilities are accessed by control and status monitoring via embedded JTAG control structures included in the Utah-400 router platform.

Further, these operations are performed in concert with the channel status (C-bit) indications at the inputs, and the channel status outputs are set appropriately, according to parameters from inputs and commanded functions.

This module also includes the provisions present on the standard output module (USI 121027-1), i.e. signal presence detection, protection input switching capability, and monitor matrix functionality.

In order to properly perform its intended function, the V-fade facility is expected to operate on signal sources that are synchronous to the router's DARS (digital audio reference signal). If either (or both) the pre- or post-switch sources are asynchronous, the hardware will still execute the commanded V-fade operation, but at the switching point, it will have to acquire the frequency and phase of the new signal, outputting an improper discontinuous AES signal while it does so. Since there can be no possible guarantees of the responses of downstream equipment, this mode of operation is not recommended and should be avoided.

All other signal manipulations are suitable for both synchronous and asynchronous AES sources.

This module is substituted for the standard output module in a Utah-400 chassis, on an as-needed basis; to bring these enhanced features to those specific system outputs.

### DAC Output Module

This circuit module, USI 121041-1, is an alternate output module for the Utah-400 digital audio router that delivers analog output signals. Like the 121040-1 deluxe output module, it has the capability to modify the characteristics of the eight AES-formatted digital audio input signals that it converts.

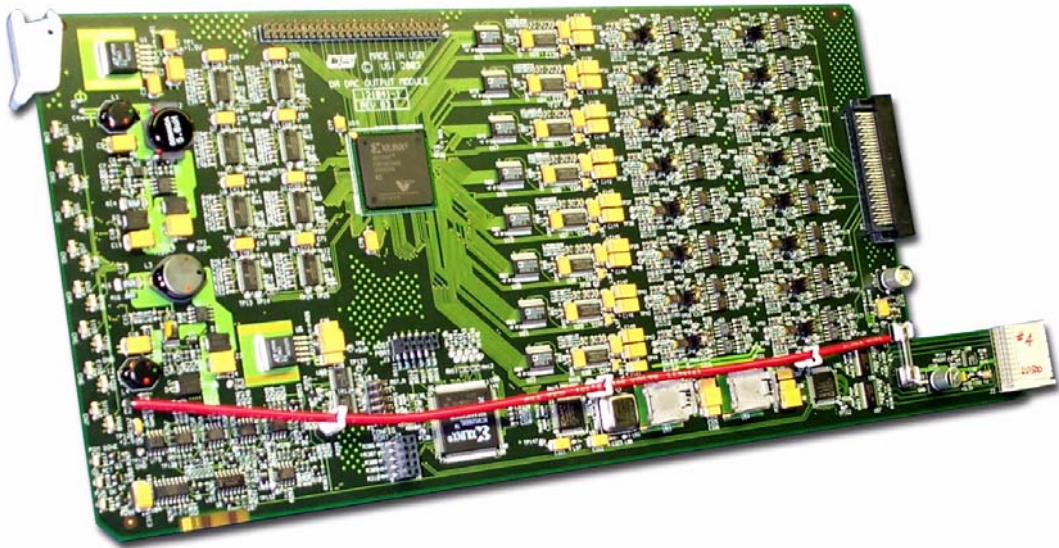

FIGURE 4-28. DAC Output Module

These capabilities include the following:

- Execution of a V-fade that ensures clickless synchronous switching of output.
- Execution of analog channel data manipulations within each AES signal pair:
- Automatic adjustment to input word lengths of 16 to 24 bits.
- Addition of dither to output signals at user discretion.

These capabilities are accessed by control and status monitoring via embedded JTAG control structures included in the Utah-400 router platform.

Further, these operations are performed in concert with the channel status (C-bit) indications at the AES inputs, with outputs set appropriately, according to parameters from inputs and commanded functions.

This module also includes the provisions present on the standard output module (USI 121027-1), i.e. AES signal presence detection, protection input switching capability, and monitor matrix functionality. In addition, payload audio signal presence detection is provided at a threshold of -48 dBfs for both embedded channels for signal integrity monitoring.

The module's digital monitor matrix output is derived from digital domain signal processing data at a point just before application to the channel's sample-rate and digital-to-analog converters. C-bits at the monitor matrix output are transmitted according to the indications at the selected input, with modifications consistent with commanded signal processing functions.

In order to properly perform its intended function, the V-fade facility is expected to operate with signal sources that are synchronous to the router's DARS (digital audio reference signal). If either (or both) the pre- or post-switch sources are asynchronous, the hardware will still execute the commanded V-fade operation, but at the switching point, it will have to acquire the frequency and phase of the new signal, extending the muting interval while it does so.

Signal processing on each AES channel includes a sample rate converter (SRC) just before that channel's digital-to-analog converter (DAC). This is done to capitalize on the jitter attenuation capability of the SRC, maximizing the resultant signal-to-noise ratio and minimizing the distortion of converted signals, independent of their specific sample rates. The DACs are always operated at 48 kHz sample-rate, as derived from a local master clock and the SRCs.

To support multi-channel operation, the SRCs can be operated with matched group delay. (The default condition, when the SRCs are operated independently, is an uncertainty of up to several milliseconds.) This is accomplished by identifying all AES signals that are part of the multi-channel (matched-phase) group. These signals must be synchronous with one another and connected to a single DAC output module. A control bit is set to identify each AES signal pair that is to be part of the group. Within the designated group, one AES signal is indicated as "phase master". The phase master conveys sample-rate conversion data to all other AES channels in the group, i.e. the slaves, locking their conversion processes together for proper multi-channel performance with uniform group delay. The phase master is designated with a control word applied through the embedded JTAG control structure.

This module is substituted for the standard output module in a Utah-400 chassis, on an as-needed basis; to bring the above enhanced features and analog functionality to those specific system outputs. Since it derives two-channel analog outputs from each AES input signal, this module requires a special output adaptor fitted with two balanced audio connectors.



### ADC Input Module

This Input module, USI 121042-1, is an alternate input module for the Utah-400 digital audio router with capability to accept eight two-channel analog input pairs, formatting them into eight AES digital audio signals for application to the routing matrix. This module is substituted for standard input modules on an as-needed basis (as constrained by options for deployment of analog I/O adaptor subassemblies and power).

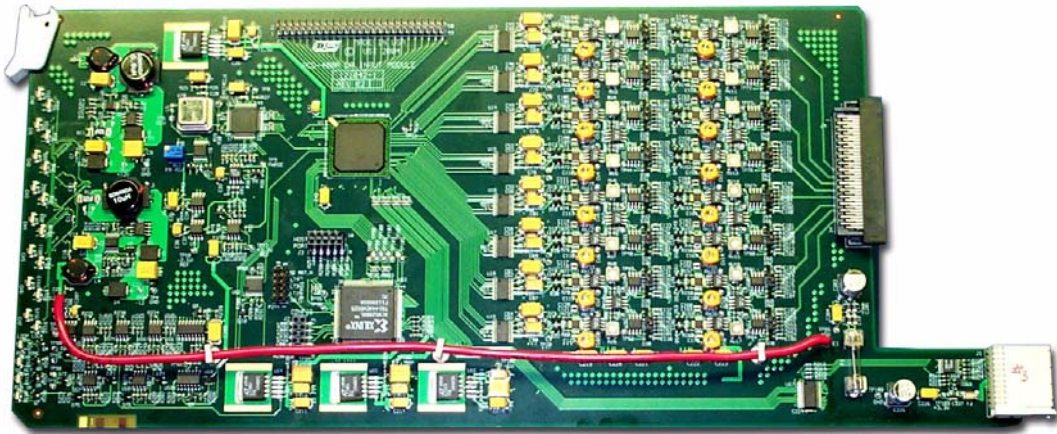

FIGURE 4-29. ADC Input Module

---

The following feature set is embodied in this module:

- Audio sample word-length adjustable to 16, 18, 20, or 24 bits, by AES channel-pair, at user discretion.
- Automatic non-subtractive dither, with triangular PDF, applied to signals configured at reduced word-lengths.
- Analog input signal presence detection at  $-48$  dBfs (28 to 30 dB below operating level) with 5-second moving detection window, provision to detect individual channel signal activity
- Selectable input muting, for each individual analog input channel.
- High-impedance bridging inputs with strap-selectable 600  $\Omega$  termination.
- Configurable “encoded channel mode” (including multi-channel modes) for C-bit indications in the AES-formatted output signals.
- Error indications for signal overload (clipping), for each individual analog input channel.

- Converted signals are synchronous to the system DARS. If the DARS is unavailable or invalid, a fallback crystal oscillator provides an asynchronous master clock rendering a 48 kHz sample rate. This module also includes the standard (for Utah-400) feature of auxiliary LVDS outputs for expansion and protection applications. Control and status reporting is accomplished via a ScanGate Type-4 chip communicating over the system's JTAG bus. Some of the module's extended features are accessed via virtual TAPs contained in its signal-processing hardware and connected to local TAPs of the ScanGate Type-4 device.



---

**Audio Crosspoint Board**

---

---

*Audio Crosspoint Board*

---

Part number 121177-1, the Audio Crosspoint card contains the same option for two imbedded controllers as its video counterpart.

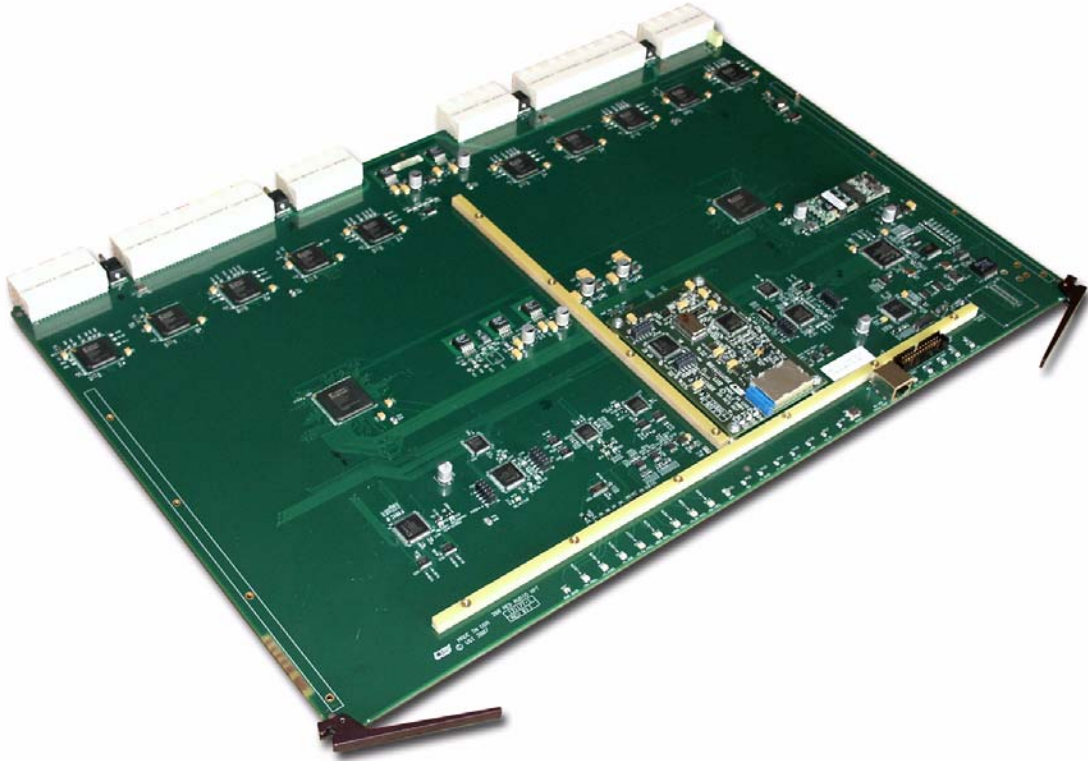

**FIGURE 4-30. Audio Crosspoint board**

---

### **Front Edge Card Indicators (Left Bank)**

#### *SGI-O (Scangage I/O)*

This indicator will be active when the commanding processor communicates out the bus to the I/O cards.

#### *SGACT (Scangate Active)*

A general indicator for processor communication. This may indicate communication between the input/output boards, or the submodule on the crosspoint card itself.

#### *SECACT*

Illuminated when the redundant FPGA is active.

#### *PGMXPT1-2*

Indicates valid programming – Green LED.

### **Front Edge Card Indicators (Right Bank)**

#### *PGMXPT3-4*

Indicates proper programming – Green LED.

#### *PWROK*

A status check for the various power supplies on the crosspoint card. Indicates Green for normal.

#### *Power Supply Fault Indications*

+3 Fail -- + 3.3 voltage D.C. Failure

-5 Fail -- -5 voltage D.C. Failure

+5 Fail-- +5 voltage D.C. Failure

+2.5V Fail -- + 2.5 voltage D.C. Failure

#### *PRIACT (primary active)*

Illuminated when the right-hand (or primary) FPGA control is active.

## Audio Crosspoint Adjustments

### *Dip Switches*

The forward dip switch indicates input and output offsets, which is identical to the video implementation.

The rear dip switch is used for level setting, which is adjusted to set the operating level, or the 'programming' level of the particular matrix.

### *Crosspoint Reset Button*

Resets the board logic – normally this is not used by the user.

This may be utilized in circumstances where power supplies are changed or other anomalies occur.

***Caution: Pressing the reset button would erase any switched up jumpers or outputs that are active.***

### *Debug Port*

Used for development and manufacturing test – not typically used by the customer. This provides a means via serial port to tie in with a computer terminal to communicate with the controllers.

## Time Base Module

Part number 121032-1, this is the master clock generator for the synchronous digital audio element. This module derives an input from the midplane I/O, performs a synchronization,

then generates a master clock scheme that is used both on the crosspoint board and all input modules.

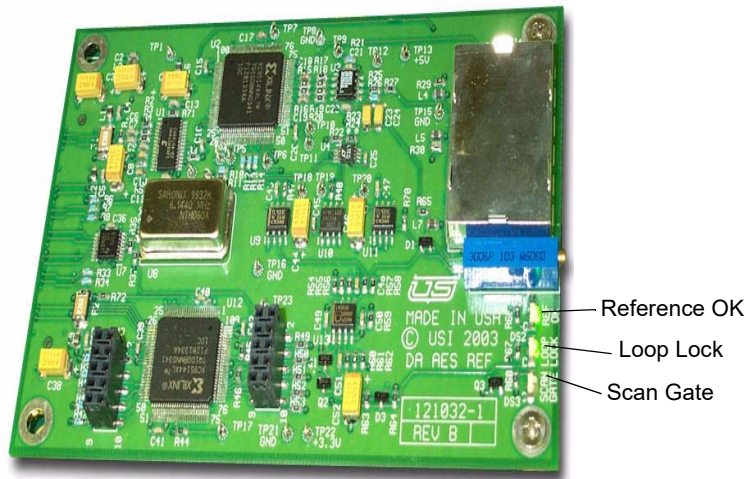

**FIGURE 4-31. Audio Time Base Module**

---

### *LED Indication*

#### **Scan Gate**

This corresponds to the internal communication bus. This indicator will flash when an internal communication element is being received.

#### **Loop Lock**

Related to the phase lock loop clock system that is implemented on this board. This indicator will appear when the module synchronizes to the reference that is presented.

#### **Ref OK**

When lit, this indicates that a suitable reference is applied to the chassis, and the module has synchronized correctly. This then sends a signal to the input cards indicating synchronization, and that they should accept the reference that is being fed to them as the master clock.

***Note: There is a fall back mode in the router if the reference is lost. The system reverts from synchronous operation to asynchronous operation. The router must remain active and continues to pass signals.***

## Fuses

The crosspoint modules are protected by self-resetting poly fuses (polymer based fuses). The circuit is opened when current overload occurs, then closes once cooling takes place. The board also contains one cartridge-type fuse, which supplies +3.34 to the crosspoint module itself.

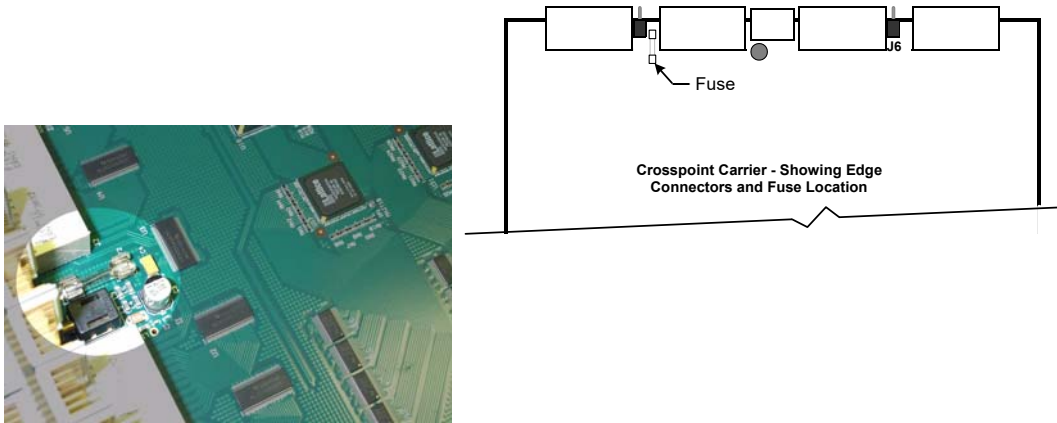

FIGURE 4-32. Crosspoint board fuse assembly

---

## Audio Crosspoint Board

---

### Test points (front of Crosspoint card)

In rare cases, engineering personnel may (when receiving certain voltage alarms) clip onto these points with a volt meter & make certain deductions regarding system voltages.

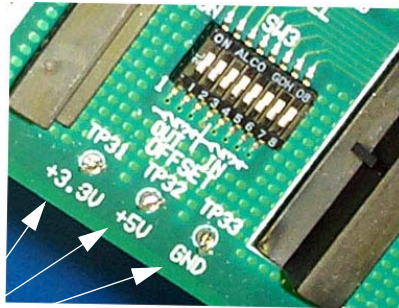

FIGURE 4-33. Audio Crosspoint board test points

---

*Contacts*

**Ground**

**+3.3**

**+5**





**Note: Parts of this section were derived from the Utah-200 Manual; some areas may not apply directly to the Utah-400 but will be corrected in the next version of this manual.**

---

*In This Chapter*

This chapter is designed to help the user diagnose problems on the Utah-400 Routers to the subsystem level. There are no repairable boards in the Utah-400 system, contact Utah Scientific Technical Services at 800-447-7204 regarding any problems you may be having. Should any printed circuit boards need repair, Technical Services can advise you on shipping and on the repair process.

Subsystem Level Troubleshooting .....	5-2
Main Troubleshooting Chart .....	5-2
Video Subsystem Troubleshooting Table .....	5-4
Audio Subsystem Troubleshooting Table .....	5-5
Power Subsystem Troubleshooting Table .....	5-6
Power Supply Alarms .....	5-6
Control Subsystem Troubleshooting Table .....	5-7
System Controller Alarms .....	5-8
Control Panel Troubleshooting .....	5-9
UNET Panels .....	5-9
Ethernet Panels .....	5-9

---

## *Subsystem Level Troubleshooting*

A routing system is typically comprised of several subsystems:

- Video System
- Audio System
- Control System
- Power System

Fault finding is simplified by first isolating the problem to one of these subsystems. For example, if the audio-system is functioning normally, but there are problems with video, the problem is probably confined to the video system.

**Note:** *With the exception of a system using Digital Video with embedded audio, audio signals are switched through a different matrix than the video signals.*

---

## *Main Troubleshooting Chart*

The following table provides an indication of what subsystems should be reviewed for common problems.

Please note:

- The numbers shown in the four Subsystem Table Reference columns indicate specific troubleshooting problems that are found in the four individual Subsystem Tables.
- For example: a 1 listed under the Video column refers to problem number 1 in the "Video Subsystem Table" on the following page. Here you will find a list of specific checks that will assist in troubleshooting the problem.

---

**Main Troubleshooting Chart**

---

**TABLE 2-1. Main Troubleshooting Table**

<b>Problem</b>	<b>Subsystem Table Reference</b>			
	<b>Video</b>	<b>Audio</b>	<b>Power</b>	<b>Control</b>
No Video or Audio outputs	1	1	1,2	1
Video and Audio outputs are present but neither can be switched	2,3	2,3		1,2,6
No Video output, Audio functions normally	1,2,3		1	2
No Audio output, Video functions normally		1,2,3	2	2
Video switches normally but audio does not switch		2,3		2
Audio switches normally but the video does not switch	2,3			2
Flash on video when switching	4			
Cannot access expansion inputs or outputs of video level	5			
Audio signal level incorrect		4		
Video signal level incorrect	7			
Video signal anomaly	5,6,8			
Video monitor matrix not functional	9			
Audio monitor matrix not functional		5		
Control panel does not function				1,2,3
Control via serial port not functional				4
Ethernet control port not functional				5
Alarm port active			3	6
SC-3/4 Ports not "Active"			3,4	4,5
Undefined level types in SC-3/4 Controller				1,2,4

## Video Subsystem Troubleshooting Table

Use the following table to troubleshoot specific video subsystem problems. The numbers in the left-hand column indicate specific references from the Video column in the **Main Troubleshooting Table**.

TABLE 2-2. Video Subsystem Troubleshooting Table

Problem	Check
1	No video output <ul style="list-style-type: none"> <li>• Control cable connected, or internal controller functional?</li> <li>• Different input works on output bus?</li> <li>• Other outputs functional?</li> </ul>
2	Unable to select a specific input <ul style="list-style-type: none"> <li>• Control panel programming correct?</li> <li>• Output signal level locked or protected?</li> </ul>
3	Unable to select any input <ul style="list-style-type: none"> <li>• Control cable connected?</li> <li>• Control panel defective?</li> <li>• Controller failure?</li> </ul>
4	Video flash when switching between inputs <ul style="list-style-type: none"> <li>• Input sources timed correctly?</li> <li>• Input reference signal present and timed?</li> <li>• Input reference correct standard?</li> <li>• Correct video standard jumper set on controller board?</li> </ul>
5	Inputs / Outputs inaccessible <ul style="list-style-type: none"> <li>• Expansion matrix crosspoint cards present?</li> </ul>
6	Sync missing on video output (analog) <ul style="list-style-type: none"> <li>• Sync present on selected input?</li> <li>• Normal DC level on input?</li> </ul>
7	Video output level incorrect <ul style="list-style-type: none"> <li>• Input level correct</li> <li>• Output terminated at destination (analog)?</li> <li>• Input/output compensation jumpers correctly set?</li> </ul>
8	Sparkles on video output (digital) <ul style="list-style-type: none"> <li>• Input signal amplitude too low?</li> <li>• Cable length &gt; 300 meters on input?</li> </ul>
9	Monitor Matrix not functional <ul style="list-style-type: none"> <li>• Selected correctly on control panel?</li> </ul>

---

### *Audio Subsystem Troubleshooting Table*

Use the following table to troubleshoot specific audio subsystem problems. The numbers in the left-hand column indicate specific references from the Audio column in the Main Troubleshooting Table.

**TABLE 2-3. Audio Subsystem Troubleshooting Table**

Problem	Check
1	No audio output <ul style="list-style-type: none"><li>• Control cable connected, or internal controller functional?</li><li>• Different input works on output bus?</li><li>• Other outputs functional?</li></ul>
2	Unable to select a specific input <ul style="list-style-type: none"><li>• Control panel programming correct?</li><li>• Output signal level locked or protected?</li></ul>
3	Unable to select any input <ul style="list-style-type: none"><li>• Control cable connected?</li><li>• Control panel defective?</li><li>• Controller failure?</li></ul>
4	Output level incorrect (analog) <ul style="list-style-type: none"><li>• Input level correct?</li><li>• Input termination in correct position?</li><li>• Output termination in correct position?</li></ul>
5	Monitor Matrix not functional <ul style="list-style-type: none"><li>• Selected correctly on control panel?</li></ul>

## Power Subsystem Troubleshooting Table

Use the following table to troubleshoot specific power subsystem problems. The numbers in the left-hand column indicate specific references from the Power column in the **Main Troubleshooting Table**.

TABLE 2-4. Power Subsystem Troubleshooting Table

Problem	Check
1 No video output	<ul style="list-style-type: none"> <li>• Power applied to video frame?</li> <li>• Warning indicators on the front of each power supply?</li> <li>• Control cable between chassis connected?</li> </ul>
2 No audio output	<ul style="list-style-type: none"> <li>• Power applied to audio frame?</li> <li>• Warning indicators on the front of each power supply?</li> <li>• Control cable between chassis connected?</li> </ul>
3 Alarm active	<ul style="list-style-type: none"> <li>• Voltage alarm active (LED on)?</li> <li>• Fan alarm active (LED on)?</li> <li>• Temperature alarm active (LED on)?</li> </ul>
4 Controller power	<ul style="list-style-type: none"> <li>• Power applied to controller frame?</li> </ul>

## Power Supply Alarms

Power supply alarms are indicated by red LEDs on the front of each power supply module. They consist of voltage, fan, and temperature alarms.

- The voltage alarm indicates that one of the supply voltages is either too high or too low.
- The fan alarm indicates that the fan has stalled.
- The temperature alarm indicates that the temperature is elevated in the power supply. This may be caused by dirt or dust blocking the airway, a defective cooling fan, or by operation in extreme temperatures.

**Note:** *Optional redundant power supplies may be fitted to UTAH-400 systems. In this configuration, the failure of a power supply should not affect normal system operations, but users would be unaware of the power supply failure. Thus, it is highly advisable to utilize the SMPTE alarm output provided at the rear of the chassis.*

## Control Subsystem Troubleshooting Table

Use the following table to troubleshoot specific control subsystem problems. The numbers in the left-hand column indicate specific references from the Control column in the **Main Troubleshooting Table**.

TABLE 2-5. Control Subsystem Troubleshooting Table

Problem	Check
1	No control of any level <ul style="list-style-type: none"> <li>• Internal controller operating (see below)</li> <li>• External controller connected</li> <li>• Control panels connected (see below)</li> <li>• MX bus terminated (see below)</li> <li>• U-Net terminated (see below)</li> <li>• Completed controller software upgrade</li> </ul>
2	No control of individual signal level or levels <ul style="list-style-type: none"> <li>• MX bus cable connected (see below)</li> <li>• MX bus correctly terminated (see below)</li> <li>• Is non functional signal level address set correctly (see below).</li> <li>• Control panel programmed correctly (see "Operations")</li> <li>• Output locked or protected on that level (see "Operations")</li> </ul>
3	Control panel not functional <ul style="list-style-type: none"> <li>• Panel address set to unique number</li> <li>• Completed panel software upgrade</li> </ul>
4	Serial control port not functional <ul style="list-style-type: none"> <li>• Communications baud rate incorrect</li> <li>• Serial control Protocol incorrect</li> <li>• Serial control cable wired correctly</li> </ul>
5	Ethernet port not functional <ul style="list-style-type: none"> <li>• Ethernet option fitted</li> <li>• Connected to PC directly by null cable</li> <li>• Connected to network via gateway</li> </ul>
6	Alarm active <ul style="list-style-type: none"> <li>• Active CPU indicator extinguished (SC-4)</li> <li>• Heartbeat indicator extinguished (SC-4)</li> <li>• MX activity light does not flash (SC-4)</li> </ul>

---

## *System Controller Alarms*

System controller alarms are indicated by LEDs on the front of each controller card.

- The active LED should be lit on one of the controller cards. If only one controller is present (non redundant system), the active LED should be illuminated.

Please note the following additional points regarding the controller:

- The heartbeat LED (DS6) indicates that the processor is communicating with the vital parts of the system and is running the application software.
- The MX LEDs indicates communication with the crosspoint matrix. The transmit LED (DS8) will flash whenever communication is being made from the controller to the matrix. The receive LED (DS7) will flash whenever communication is being received by the controller from the matrix.
- U-Net is used for communication between the controller and the control panels. The U-Net data and U-Net transmit enable LEDs (DS9 and DS10) indicate when information is exchanged between the system controller and a control panel.
- If the active LED is on and the U-Net transmit enable LED (DS10) is off, this indicates that a controller software upgrade has failed and the controller is waiting for a valid controller software upgrade to be uploaded.
- If used with an SC-4 or SC-400 system controller consult the appropriate controller manual for details about the controller card.
- The total MX bus cable length must be less than 300 feet and must be terminated at the last chassis.



---

## *Control Panel Troubleshooting*

If your control panel does not control any of the matrix, check that power is applied to the panel.

### **UNET Panels**

- Panels communicate to the controller by a special network known as U-Net. Panels are connected together daisy chain style to the controller. Removing a panel physically from the network will break the chain and disconnect panels downstream from the controller.
- U-Net uses unshielded twisted pair cable. It requires two twisted pairs terminated in an RJ 45 connector. The maximum length of any segment is 1000 feet and must be terminated at the last control panel in each segment. Refer to the Appendix C "U-Net Cabling" for details.
- The panel may be communicating to the controller correctly, but the required signal level matrix may not be responding. Check the Dipswitch setting on the rear panel of the non-functional router level.

***Confirm that the control panel address is a unique number. Each panel address is set by a rear panel Dipswitch and must be a unique address. This control panel address is read when the control panel is powered up.***

### **Ethernet Panels**

- Panels should be connected to the same network as the SC-3/4 controller.
- There should be a network hub between a panel and the SC-3/4 controller.
- Unique IP addresses.
- CAT-5 cable lengths should be less than 100 meters.



# *Specifications*

---

## *In this Appendix*

This appendix provides detailed lists of all system audio, video, control, physical, power and regulatory specifications.

Power .....	A-2
Input Power and DC Power Specifications .....	A-2
Digital Video .....	A-3
Digital Audio .....	A-4
High Definition SDI Video .....	A-5
Reference .....	A-5
Control .....	A-6
Alarms .....	A-7
Physical .....	A-8
Regulatory .....	A-8
Connector Suppliers and USI Part Numbers .....	A-9

---

**Specifications**

---

---

**Power**

The following table lists power specifications:

---

***Input Power and DC Power Specifications***

---

**TABLE A-1.**

---

<b>Parameter</b>	<b>Specification</b>
<b>(AC Supply)</b>	
Input Power Consumption	600 Watts
Voltage	90 - 240 Volts AC, universal power supply
Frequency	50 - 60 Hertz
Redundancy	Dual Redundant power supplies (optional)
<b>DC Output Voltages (From external supply)</b>	
48 volts	20 Amps
<b>DC Output Voltages (From internal converters)</b>	
5 Volts	40 Amps
3.3 Volts	32 Amps

---

*Digital Video*

The following table lists the system digital video specifications.

**Digital Video Specifications****TABLE A-2.**

---

<b>Parameter</b>	<b>Specification</b>
Jitter and all other specifications	Conforms to SMPTE 259M; 292M
Data Rates	143, 177, 270, 360 and 540 Mb/Sec With SD Re-clocking
Input Return Loss	>15 dB, 6 MHz. – 360 MHz*
Output Return Loss	>15 dB, 6 MHz. – 360 MHz*
Input Equalization up to 360 Mbps	1000 ft. for 8281 cable
Signal Level	800 mV $\pm$ 10%

\* >10db for cards operating at 1.5Gb to 3Gb/Sec

---

## *Digital Audio*

The following table lists system digital audio specifications

### **Digital Audio Specifications**

**TABLE A-3.**

---

<b>Parameter</b>	<b>Specification</b>
<b>Digital Audio Processing</b>	48 kHz. 16 - 24 Bit, AES / EBU; AES-3
<b>Input Impedance - Balanced</b>	110 $\frac{3}{4}$ $\pm$ 20%. 100 KHz. to 6.144 MHz
Input Level minimum:	200 mVPP. w/> 50% Eye Pattern Opening
Modes of Operation	Synchronous and Asynchronous
Input Level maximum:	7 VPP
Common Mode Range:	$\pm$ 7V (DC + Peak Signal)
Common Mode Rejection:	Per AES-3, Section 6.3.5 (1997)
Output Impedance - Balanced	110 $\frac{3}{4}$ $\pm$ 20%, 100 kHz. to 6.144 MHz
Output Amplitude:	2.0 VPP into 110 $\frac{3}{4}$ , minimum
Nominal Rise / Fall Times:	25 nano seconds
Common Mode Rejection:	>30 dB, DC to 6 MHz
Sample Rate:	48 kHz
Intrinsic Jitter:	< 0.025 UI Peak, w/700 Hz. HPF Applies to discrete AES outputs
Output Phasing with respect to DARS Input:	$\pm$ 2.5% ( $\pm$ 9 $^{\circ}$ ) of Frame Interval. Applies to discrete AES outputs

---

*High Definition SDI Video*

The following table lists the high definition specifications:

**High Definition SDI Video Specifications**

TABLE A-4.

Parameter	Specification
Video Standard	10 Bit SDV, Conforms to SMPTE 292M
Data Rate:	1.4835 Gbps / 1.485 Gb/Sec
Input Return Loss:	>15 dB; 5 MHz. – 1.485 Gb/Sec
Output Return Loss:	>15 dB, 5 MHz. – 1.485 Gb/Sec
Automatic input equalization:	>150 Meters with 1694A coaxial cable
Output Re-Clocking:	Jitter, < 0.2 UIpp (average)

---

*Reference*

The table below lists reference specifications

**Reference Specifications**

TABLE A-5.

Parameter	Specification
Audio	One 75Ohm terminated AES sync

---

*Control*

The following table lists control specifications:

**Control Specifications**

TABLE A-6.

Parameter	Specification
Control	MX-Bus Daisy Chain - Terminated
Audio	One AES Audio Sync
SMPTE Alarm	(see below)

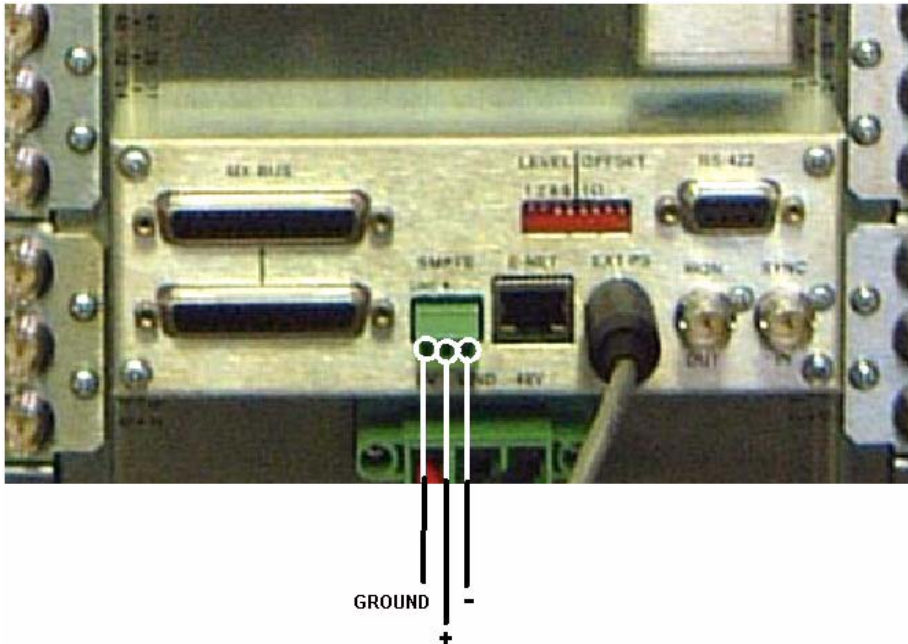

The (+) and (-) connections (above) represent two legs of a dry contact closure whenever an alarm condition exists. (Limited to a 20 milliamp current carrying capacity.)



---

**Alarms**

---

---

*Alarms*

The following table lists alarm specifications:

**Alarm Specifications****TABLE A-7.**

<b>Parameter</b>	<b>Specification</b>
Primary alarm	ANSI / SMPTE 269M fault reporting(Relay closure)
Connector Type	Phoenix Male Barrier Strip – 3 pin
Functions	<ul style="list-style-type: none"><li>• Power</li><li>• Temperature</li><li>• Fans</li><li>• System Board Failure</li></ul>
Maximum current	20 milli-Amp

---

**Specifications**

---

---

*Physical*

The following table lists physical specifications:

**Physical Specifications****TABLE A-8.**

---

<b>Parameter</b>	<b>Specification</b>
Width	EIA – RS-310 – D 92 19” rack mount standard
Height	15 rack units, 356 mm
Depth	19 inches, 483 mm maximum
Weight	150 pounds
Mounting	Eight front mount rack ears
System connectors	All connectors rear panel mounted
Cooling	8 Fans – rear exhaust
Temperature range	10 – 40 Degrees Celsius
Humidity range	0 – 90% non - condensing

---

*Regulatory*

The following table lists system regulatory specifications

**Regulatory Specifications****TABLE A-9.**

---

<b>Parameter</b>	<b>Specification</b>
EMC	EN50 081-1 (EN50 022 Class A)
Susceptibility	EN50 082 (IEC 801-3, IEC 801-4)
Safety	EN60 950, UL 1950, CSA 022.2 No. 234
Shock / Vibration	MIL Std. 810E, Method 514.4(cargo truck 500 / 500 miles)

*Connector Suppliers and USI Part Numbers*

The following table lists connector supplies and Utah Scientific Part Numbers where applicable: Not all connectors are used on the Utah-400 but are supplied as a courtesy.

**Connector Suppliers**

**TABLE A-10.**

<b>Manufacturer Part Description</b>	<b>Part Number</b>	<b>USI Part No.</b>	<b>Contact</b>
Advanced Connectek USA Inc.			714 – 573-1920
<ul style="list-style-type: none"> <li>DB-26B – Male connector, crimp</li> </ul>	DH-26PK-SFG-T	41226-2026	
Conec Corp.			Ontario, Canada 905 – 790-2200 American Conec Corp. 102 Pleasant Wood Ct. Morrisville, NC 27560 (919) 460-8800
<ul style="list-style-type: none"> <li>DB-26B – Male connector, solder cup</li> </ul>	CDS26LFHD SN163A1660 9X	41226-3026	
Amp			AMP Inc. Harrisburg, PA 17105 (800) 522 – 6752
<ul style="list-style-type: none"> <li>BNC Male connector</li> </ul>	225395-2 5-569278-2	41215-0001 41211-0011	
<ul style="list-style-type: none"> <li>RJ-45 Male connector</li> </ul>	747904-2	41223-1009	
<ul style="list-style-type: none"> <li>DB-9B Male connector</li> </ul>			
Phyco			Kimball Electronics 1600 Royal St.; GO-149 Jasper, IN 47549 (800) 634-9497
<ul style="list-style-type: none"> <li>6 pin CirDin</li> </ul>	A-9001-069	41329-1006	

---

**Specifications**

---

## *The Debug Port*

---

This Appendix contains the following:

Using the Debug Port .....	B-3
Startup Display .....	B-4
Main Menu Display .....	B-4
FPGA Memory Status .....	B-5
Verifying the Software Version .....	B-5
Checking the Router Crosspoint Status .....	B-6
IO Card Information .....	B-7
Checking Input / Output Card Information .....	B-9
IO Information – full display .....	B-10
Hardware Status .....	B-11
External PS Status .....	B-12
Crosspoint Voltage (Levels) .....	B-14
'DC CONV readings' .....	B-14

---

## The Debug Cable

The Debug Cable is a full duplex serial cable, consisting of an RJ-45 Connector on one end and DB-9S (female) connector at the other end. Refer to the figure below if you wish to build your own cable for the debug port.

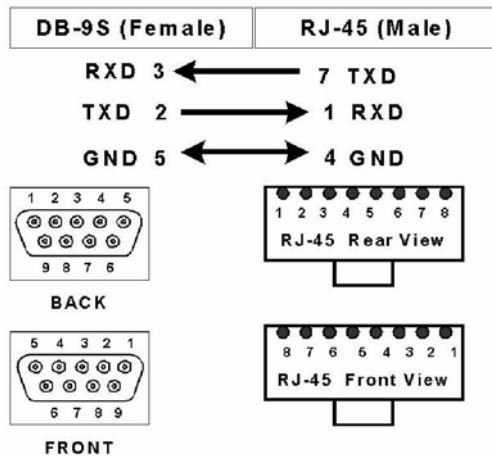

FIGURE B-1. Debug Port Cable Pinouts

---

The terminal settings for the debug port are: **Baud Rate = 38.4 K baud; 8 Data Bits; 1 Stop Bit; No Parity; Handshake = XON/XOFF, ASCII Translation and CR = CRLF** (carriage return, line feed).

The Hyper-Terminal will have the same settings as above; but since the Hyper –Terminal does not have a CRLF setting a similar parameter is set by doing the following:

- Click on “Open Port” and set the Baud Rate, Parity, and Stop Bits.
- Select “None” in the Flow Control Box”, Click “OK”.
- On the Hyper-Terminal window select “File”, click on “Properties”.
- Click the “Settings Tab” in the Properties Window.
- Click the “**ASCII Setup**” Button.
- In the “ASCII Receiving Block” at the bottom of the window, **checkmark** (enable) the “**Append Line Feed to Incoming Line Ends**” and “**Wrap Lines that Exceed Terminal Width**”. These parameters perform the same function as the Terminal’s CRLF Setting.

---

## *Using the Debug Port*

The debug port is the RJ-45 female connector labeled J1, located on the left hand side of the crosspoint. Its capabilities include:

- System **Power Up** Display
- **Main Menu** Display.
- Verifying the **FPGA Memory Status**.
- Verifying the **Software Version**.
- Checking the **Router Crosspoint Status** to verify switching.
- Checking the **I / O Card Information**.
- Checking the **Hardware Status**.

Only the “Active” FPGA Control board will be read by the Debug Port. By pressing the “Reset” button on the currently active FPGA board, the control should be transferred to the inactive board.

If both FPGA's are to be checked, be sure to press the “Reset” button after reading the first board.

***Caution: Resetting the control card will cause a brief interruption of all Audio/ Video paths in the system.***

### Startup Display

If the debug port and terminal is connected to the Utah-400 system during the power up sequence, the following display will appear on the terminal.

```
*****  
                Utah Scientific Inc.  
            Utah-400 System Monitor, Rev. X.X  
*****
```

Set to Primary

The display should show the Monitor Revision you currently have in your system. Contact Utah Scientific Technical Services to verify your revision or to upgrade to a higher version, if available.

### Main Menu Display

The main menu displays the selections possible on the FPGA Debug port.

After connecting the debug port to the crosspoint board, activate the Main Menu by pressing <Enter> or <Return> on the terminal or computer. The display will be as shown below and is self explanatory:

```
Menu-  
M = FPGA Memory Status  
V = Version  
R = Router Crosspoint Status  
I = IO Card Information  
S = Hardware Status
```



### FPGA Memory Status

Typing an upper or lower case “M” on the keyboard activates this feature. This display function enables the user to examine the crosspoint status as reported by the FPGA Controller. The status display and explanation is shown below.

<b>FPGA MEMORY STATUS</b>	<b>Min / Max Values</b>
<b>Level Switch = 00</b>	Range = 00 to 1F
<b>Offset Switch = 00</b>	Range = 00 to FF
<b>MX Active? -&gt; YES.</b>	Yes / No
<b>Monitor Matrix = FF</b>	Range = 00 to 1F
<b>Primary / ID Reg = 01</b>	01 or 61 only
<b>FPGA Rev = X.XX</b>	Reflects Current Version

Parameter	Description
Level Switch	Reflects the Router Level that is selected when the dipswitch is turned “Off” (toward the silkscreen number) on the crosspoint board.
Offset Switch	Reflects any router offsets selected.
MX Active	Indicates the MX Bus is active. If there is a “No” showing in this block, the MX Cable may be disconnected or the MX Bus daisy chain may not be terminated.
Monitor Matrix	Reflects the Monitor Output currently switched up. FFh = Default, Mon. Mtx. not switched up.
Primary / ID Reg	Indicates FPGA is functioning. 01 = Digital Video 61 = Digital Audio
FPGA Revision	Subject to change.

### Verifying the Software Version

This feature is the same as the Start Up Display with the exception of the “Set to Primary” message. Typing an upper or lower case “S” on the keyboard activates this feature. The displayed data is shown below.

```
*****  
                Utah Scientific Inc.  
            Utah-400 System Monitor, Rev. X.X  
*****
```

### Checking the Router Crosspoint Status

To activate this feature press an upper or lower case “R” on the keyboard. This feature displays all of the crosspoint and indicates which crosspoint are switched up. The table displayed is arranged in blocks of 16.

When the router is initially powered up the display will be all FF’s. This screen displays the Inputs that are switched up to the respective output in the crosspoint matrix. To check if an Input / Output has been switched up, first switch up the Input / Output and then press “R” again to refresh the screen. The display should reflect the Input / Output change to the router matrix.

Thus, if Input 00 is switched up to all outputs, after pressing “R” the crosspoint status block will show all 00’s.

An example of the screens is shown below:

Crosspoint display after router is powered up (Hexadecimal):

```
ROUTER STATUS
0+000 FF,FF,FF,FF,FF,FF,FF,FF,FF,FF,FF,FF,FF,FF,FF,
0+010 FF,FF,FF,FF,FF,FF,FF,FF,FF,FF,FF,FF,FF,FF,FF,
0+020 FF,FF,FF,FF,FF,FF,FF,FF,FF,FF,FF,FF,FF,FF,FF,
0+030 FF,FF,FF,FF,FF,FF,FF,FF,FF,FF,FF,FF,FF,FF,FF,
0+040 FF,FF,FF,FF,FF,FF,FF,FF,FF,FF,FF,FF,FF,FF,FF,
0+050 FF,FF,FF,FF,FF,FF,FF,FF,FF,FF,FF,FF,FF,FF,FF,
0+060 FF,FF,FF,FF,FF,FF,FF,FF,FF,FF,FF,FF,FF,FF,FF,
0+070 FF,FF,FF,FF,FF,FF,FF,FF,FF,FF,FF,FF,FF,FF,FF,
0+080 FF,FF,FF,FF,FF,FF,FF,FF,FF,FF,FF,FF,FF,FF,FF,
```

**FIGURE B-2. Crosspoint display (hex)**

---

### IO Card Information

Cd 00 PN:1170-2030 IO = 0000000000 | Cd 01 PN:1171-1030 IO = 0000000000 |  
Cd 02 PN: Not Installed | Cd 03 PN: Not Installed |  
Cd 04 PN: Not Installed | Cd 05 PN: Not Installed |  
Cd 06 PN: Not Installed | Cd 07 PN: Not Installed |  
Cd 08 PN: Not Installed | Cd 09 PN: Not Installed |  
Cd 0A PN: Not Installed | Cd 0B PN: Not Installed |  
Cd 0C PN: Not Installed | Cd 0D PN: Not Installed |  
Cd 0E PN: Not Installed | Cd 0F PN: Not Installed |  
Cd 10 PN: Not Installed | Cd 11 PN: Not Installed |  
Cd 12 PN: Not Installed | Cd 13 PN: Not Installed |  
Cd 14 PN: Not Installed | Cd 15 PN: Not Installed |  
Cd 16 PN: Not Installed | Cd 17 PN: Not Installed |  
Cd 18 PN: Not Installed | Cd 19 PN: Not Installed |  
Cd 1A PN: Not Installed | Cd 1B PN: Not Installed |  
Cd 1C PN: Not Installed | Cd 1D PN: Not Installed |  
Cd 1E PN: Not Installed | Cd 1F PN: Not Installed |  
Cd 20 PN: Not Installed | Cd 21 PN: Not Installed |  
Cd 22 PN: Not Installed | Cd 23 PN: Not Installed |  
Cd 24 PN: Not Installed | Cd 25 PN: Not Installed |  
Cd 26 PN: Not Installed | Cd 27 PN: Not Installed |  
Cd 28 PN:1016-10A1 IO = 0000000000 | Cd 29 PN: Not Installed |  
Cd 2A PN: Not Installed | Cd 2B PN:1128-1030 IO = 0000000000 |  
Cd 2C PN: Not Installed | Cd 2D PN: Not Installed |

Cd 2E PN: Not Installed | Cd 2F PN: Not Installed |  
Cd 30 PN: Not Installed | Cd 31 PN: Not Installed |  
Cd 32 PN: Not Installed | Cd 33 PN: Not Installed |  
Cd 34 PN: Not Installed | Cd 35 PN: Not Installed |  
Cd 36 PN: Not Installed | Cd 37 PN: Not Installed |  
Cd 38 PN: Not Installed | Cd 39 PN: Not Installed |  
Cd 3A PN: Not Installed | Cd 3B PN: Not Installed |  
Cd 3C PN:1170-1030 IO = 0000000000 | Cd 3D PN: Not Installed |  
Cd 3E PN: Not Installed | Cd 3F PN: Not Installed |  
Cd 40 PN: Not Installed | Cd 41 PN: Not Installed |  
Cd 42 PN: Not Installed | Cd 43 PN:1015-10A1 IO = 0000000000 |  
Cd 44 PN: Not Installed | Cd 45 PN:0966-1003 IO = 0000000000 |  
Cd 46 PN:1170-1010 IO = 0000000000 | Cd 47 PN: Not Installed |  
Xpt = 1174-1020 Pri/Red = 01

### Checking Input / Output Card Information

Typing the upper or lower case "I" activates this feature. This display provides up to date information on the types of Input and Output boards in the system, the revision of each board and the Monitor Matrix Output that is switched up.

The display format (per line) is shown below:

	①		②	③	④		⑤	⑥	⑦	⑧	⑨
Cd	XX	PN:	XXXX	- XX	XX	IO =	00	00	00	00	00

- |  |  |
|--|--|
| <p>① Chassis location of Card:<br/>Range - 00h to 27h</p> <p>② Four Digit Part Number of Card</p> <p>③ Card Dash Number</p> <p>④ Card Revision Number</p> <p>⑤ Signal Presence Indicator</p> | <p>⑥ Card Specific<br/>Range = 00h to FFh</p> <p>⑦ Card Specific<br/>Range - 00h to FFh</p> <p>⑧ Card Specific<br/>Range - 00h to FFh</p> <p>⑨ Monitor Matrix Output Reported;<br/>(Indicated on Output boards only)<br/>08h = Out 0, Monitor Matrix Enabled;<br/>0Fh = Out 7 on; Default = 8Fh;<br/>Off = 00h</p> |
|--|--|

Cd	00	PN:	1026	- 10A0	IO =	01	00	10	00	0F
----	----	-----	------	--------	------	----	----	----	----	----

Typical Data represented by a Digital Audio Input Board: Card Slot 00, Board Part Number = 1026, Dash Number = 10, Revision A, IO Data = Input 00 contains **signal present**.

Cd	05	PN:	1027	- 1001	IO =	01	04	00	00	00
----	----	-----	------	--------	------	----	----	----	----	----

Typical Data represented by a Digital Audio Output Board: Card Slot 05, Board Part Number = 1027, Dash Number = 10, Revision 01, IO Data = Output 00 contains **signal present**.

- ⑤ **Signal Presence Indicator:** The byte of information contains a single bit that indicates presence (1) or not (0) for each input or output on the card.

Input / Output	0	1	2	3	4	5	6	7
Value	01	02	04	08	10	20	40	80

FIGURE B-3. Display format - I/O card info

**Note:** These values Add if more than 1 I/O contains a signal. (FF = All Signals Active)

## IO Information – full display

The complete terminal display of IO Information is shown below. This is how this screen should appear, dependent on the size of your system. A smaller system will have a larger portion of the screen showing boards “Not Installed”. Note: on the bottom of the display, data on the system crosspoint is reflected. This data is also available in the Hardware Status feature.

```
IO CARD INFORMATION =
Cd 00 PN:0967-1003 IO = 000000000F | Cd 01 PN:2407-1003 IO =
0400000000 |
Cd 02 PN:2407-1003 IO = 0000000000 | Cd 03 PN:2407-1003 IO =
0000000000 |
Cd 04 PN:2407-1003 IO = 0000000000 | Cd 05 PN:2406-1003 IO =
FF00000000 |
Cd 06 PN:0966-1003 IO = FF00000000 | Cd 07 PN:0966-1003 IO =
FF00000000 |
Cd 08 PN:2406-1003 IO = FF00000000 | Cd 09 PN:0966-1003 IO =
FF00000000 |
Cd 0A PN:2407-1003 IO = 0000000000 | Cd 0B PN:2407-1003 IO =
0000000000 |
Cd 0C PN:2407-1003 IO = 0000000000 | Cd 0D PN:2407-1003 IO =
0000180000 |
Cd 0E PN: Not Installed | Cd 0F PN:2406-1003 IO =
FF00000000 |
Cd 10 PN:2406-1003 IO = FF00000000 | Cd 11 PN:0966-1003 IO =
FF00000000 |
Cd 12 PN:2406-1003 IO = FF00000000 | Cd 13 PN: Not Installed
|
Cd 14 PN:2407-1003 IO = 0100000000 | Cd 15 PN:2407-1003 IO =
0000000000 |
Cd 16 PN:2407-1003 IO = 0000000000 | Cd 17 PN:2407-1003 IO =
0000000000 |
Cd 18 PN:2407-1003 IO = 0000000000 | Cd 19 PN:2406-1003 IO =
FF00000000 |
Cd 1A PN:2406-1003 IO = FF00000000 | Cd 1B PN:2406-1003 IO =
FF00000000 |
Cd 1C PN:2406-1003 IO = DF00000000 | Cd 1D PN: Not Installed
|
Cd 1E PN:2407-1003 IO = 0000000000 | Cd 1F PN:2407-1003 IO =
0000000000 |
Cd 20 PN:4128-1001 IO = DF00000000 | Cd 21 PN:4128-1001 IO =
FF00000000 |
Cd 22 PN: Not Installed | Cd 23 PN:2406-1003 IO =
FF00000000 |
Cd 24 PN:2406-1003 IO = FF00000000 | Cd 25 PN:4121-1001 IO =
8000000000 |
Cd 26 PN:4121-1001 IO = F700000000 | Cd 27 PN: Not Installed
|
Crosspoint = 4120-105A
```

**FIGURE B-4. I/O info - Full display**

---

### Hardware Status

Crosspoint type = HD/SD 288x288 Red

Slot = Primary

XPT Voltage Levels

5V = 4992mv

1.2 #1 = 1209mv

1.2 #2 = 1209mv

1.2 #3 = 1196mv

1.2 #4 = 1196mv

XPT Power = 27W

Fan Status =

\*Fan 1-2 FAIL.\* \*Fan 3-4 FAIL.\* \*Fan 5-6 FAIL.\* \*Fan 7-8 FAIL.\*

DC CONV readings - PG | 5V | 33V |5BIAS|3BIAS| Temp

DC Converter 1 - Not Installed

DC Converter 2 - OK |5374mv| OK |ON | ON |31C

DC Converter 3 - Not Installed

DC Converter 4 - OK |5374mv| OK |OFF | OFF |30C

### External PS Status

Reflects the status of the power supplies installed in the system and reports any errors. The temperature of each power supply is also monitored in Celsius. If a power supply is not installed, there is a "No" following the arrow.

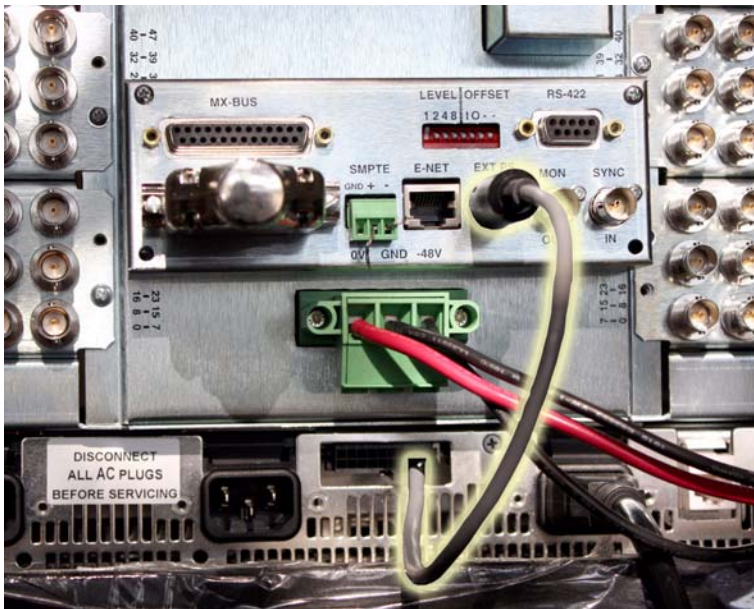

FIGURE B-5. External Power Supply cabling

---

A four-digit code will be displayed next to the FAIL indication when an error is detected. The following contains examples and descriptions of this code.

External PS		
SLOT	01	OK
SLOT	02	OK
SLOT	03	NI
SLOT	04	NI

FIGURE B-6. Power Supply indication - New

---



External PS  
SLOT 01 FAIL 0102

FIGURE B-7. Failure Example

*Power Supply - Descriptive Detail*

Variable Name	Offset	Data Type	Description	Read/Write
STATUS - STAT_DC_ON - STAT_BOOST_OK - STAT_AC_OK - STAT_HVSD	00h	ushort	<u>Rectifier Status</u> 0001h 1 = DC/DC enabled 0002h 1 = Boost Voltage OK 0004h 1 = AC input voltage OK 0008h 1 = Output shut down due to hi-voltage	Read Only
- STAT_FAN_FAIL - STAT_INT_TEMP - STAT_ILIM			0010h 1 = Fan failure 0040h 1 = Heatsink over temperature alarm 0080h 1 = Current limit	
- STAT_UV_ALARM - STAT_UVSD - ..... - STAT_DC_ENABLE			0100h 1 = Output Voltage below UV alarm threshold 0200h 1 = Output shut down due to lo-voltage 0400h Unused 0800h 1 = DC enable asserted	
- STAT_REMOTE_OFF - STAT_MOD_DISABLE - STAT_SHORT_PIN - .....			1000h 1 = Shutdown due to 12C remote off command 2000h 1 = Shutdown due to MOD_DISABLE input 4000h 1 = Shutdown due to short pin transition 8000h Unused	

FIGURE B-8. Rectifier Variable Definitions

### **Crosspoint Voltage (Levels)**

This applies to the voltage levels of the 5 power supplies on the 121174-1 crosspoint card themselves. It gives you the actual voltage readings on the crosspoint. Nominal levels are 5000mv and 1200 mv.

### **'DC CONV readings'**

This applies to the performance of the four 121172-1 converter modules in the frame. They are numbered from bottom to top, with #1 being on the bottom. The individual indications are as follows:

'PG' - Pass / Fail indicator of the health of the converter module. OK or Fail

5V - Voltage readings, in MV, or the 5V output. Nominal is approximately 5300mv.

33V - Pass fail indicator of the 3.3V rail output. OK or Fail

5BIAS - On means this converter is sharing with the other converter in its pair. OFF means it is not.

3BIAS - On means this converter is sharing with the other converter in its pair. OFF means it is not.

TEMP - Converter card temperature in Celsius.

*The Utah-400 Digital Audio  
Breakout Panel*

---

This Appendix contains the following:

Scope .....	C-2
The AES Breakout Panel Kit .....	C-2
Description of the AES Breakout Panel .....	C-2
Installation of the AES Breakout Panel .....	C-2
Label Instructions for the Utah-400 Breakout Panel ...	C-5
Scope .....	C-5
Application .....	C-5

---

## *Scope*

This Appendix applies only to the installation of the AES Digital Audio Break Out Panel. The Breakout Panel and Cables are pre-tested at the factory before shipment and do not need any modifications. The customer is responsible for wiring the Sources and Destinations to each panel.

---

## *The AES Breakout Panel Kit*

Each breakout panel kit ordered from Utah Scientific is shipped with the following items:

- (1) Breakout Panel (part number 161044-1)
- (9) 3 foot D/D 26 pin high density cables (part number 65366-3)
- (1) field wiring kit, which includes nine tension grip connectors and nine hoods.

---

## *Description of the AES Breakout Panel*

The AES Breakout Panel is designed to simplify the installation of the Utah-400 Balanced Digital Audio Routing System. The 26 pin high-density connectors are pre-wired to connect directly between the Utah-400 Balanced Digital Audio backplane and the breakout panel. Only a screwdriver is needed for this installation.

The Breakout panels are generic; they may be used for either sources or destinations.

Each panel is silk screened from 0 on the left, to 71 on the right. Each labeled block on the rear of the panel corresponds to the labeled block on the front of the panel.

---

## *Installation of the AES Breakout Panel*

To install the Breakout Panel:

1. Install the BOP at the desired location on the rack frame. (Within three feet of the Utah-400 Digital Audio Backplane.)
2. Install the D/D 26 pin cables from the Utah-400 input or output 00 - 07 to the BOP backplane input or output 00 - 07. Continue in the same manner for each input or output for the remaining eight blocks on the breakout panel.
3. Unpack the Field Wiring Kit and connect the required sources or destinations to each of the tension clamp connectors. Refer to Figure C-2, on the following page for wiring each tension clamp connector.

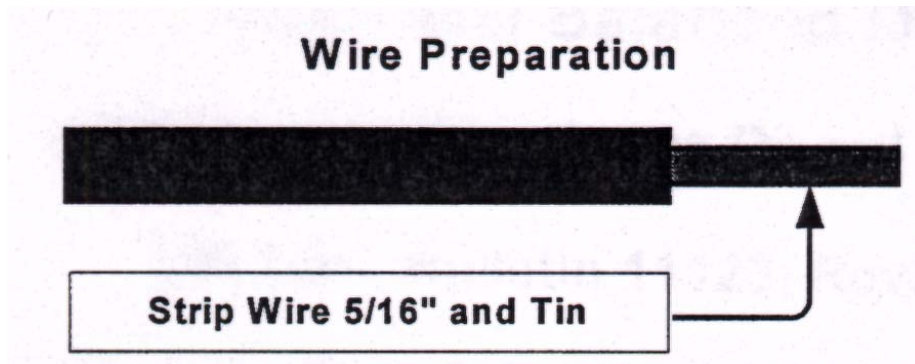

FIGURE C-1. Wire Prep

1. Insert the small screwdriver into the rectangular holes to release the wire clamp.
2. Insert the wire into the round hold above or below the rectangular slot.
3. While holding the wire in the hole, pull out the screwdriver (inserted in Step 1).
4. Tug on the inserted wire to verify that it is properly clamped.
5. Repeat for the entire connector.

*Note: Wiring is the same for each sequential block following 0 - 7. Example; 8 - 15, 16 - 23, etc. **Failure to follow these steps will result in loose or no connections, and the wire may fall out of the hole.***

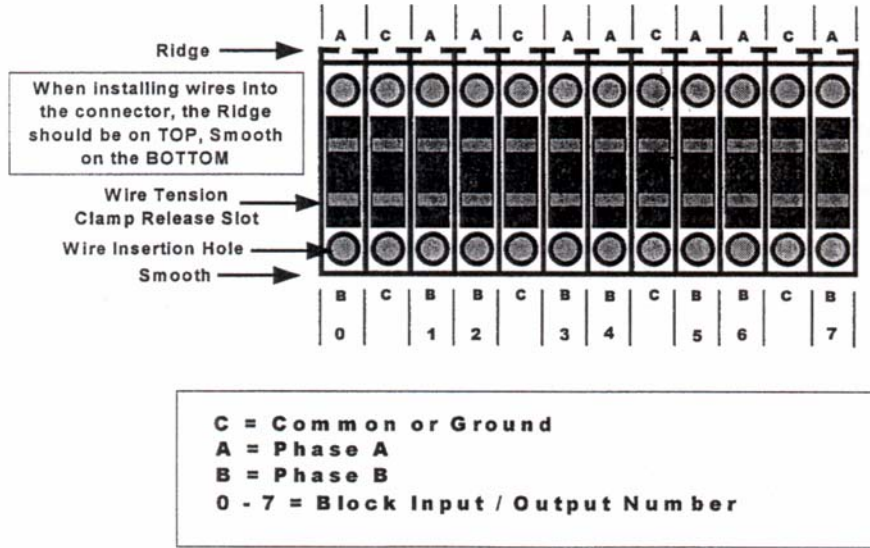

FIGURE C-2. Tension Clamp Connector (viewed from the back)

---

## *Label Instructions for the Utah-400 Breakout Panel*

### **Scope**

This document applies to the label installation on the Utah-400 Breakout Panel. Labels included in this kit include the 54450-1035 (Input Labels 000 through 287) and 54450-1036 (Output Labels 000 through 287).

Section Two of this document shows the proper wiring techniques to use on the Breakout Panel.

### **Application**

The labels provided for the Utah-400 Breakout Panels are to be applied over the silk-screened blocks (00 – 71) below the front and back connectors on each panel. Each label sheet has two labels for each input / output range (e.g. 000 – 007) for this application.

Each label sheet will consecutively label up to four breakout panels from Inputs 000 through 287 and four breakout panels from Outputs 000 through 287.

If you do not receive enough labels for your particular application, contact Utah Scientifics' Technical Services at 1-800-447-7204 for additional labels.

The illustration below shows the proper application of the labels on the breakout panel.

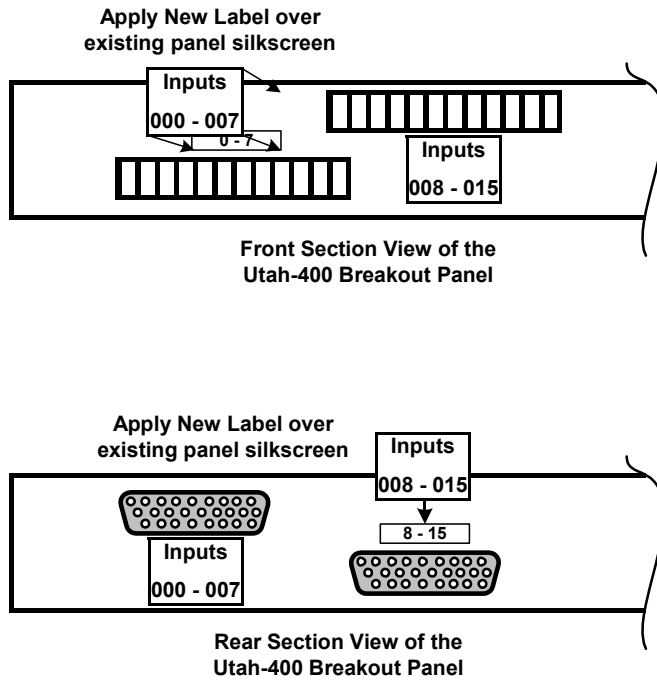

FIGURE C-3. Breakout Panel Label Application



## *Crosspoint Card Firmware Upgrade*

---

### *Scope*

The firmware on the 288r Crosspoint Card (121174-1) will provide the ability to field reprogram the DSP. Before you attempt to upgrade software in the card, consult with Utah Scientific Customer Service to ensure you are upgrading to the proper version for your application.

### *Process*

Before attempting, ensure that you have connected to the card as described in Section 2 of this manual. And are able to access the menus using TeraTerm. Information regarding TeraTerm's installation and configuration can be found in the Utah Scientific System Installation Guide.

***CAUTION - THIS UPGRADE WILL RENDER THE CARD INOPERABLE FOR 1 MINUTE. IF YOUR SYSTEM DOES NOT INCLUDE A REDUNDANT CROSSPOINT CARD, WAIT FOR A SUITABLE TIME WINDOW TO PERFORM THE UPGRADE.***

Follow the procedure below to program this board.

1. Using a CAT5 cable with the 140000-8 serial adapter (or similar), connect to COM1 of your computer, then to P1 of the 121174-1. If the system is in use, connect to the redundant crosspoint card, identified by the illuminated 'REDUN' LED, DS6.
2. Open TeraTerm on your PC.
  - Set it up for COM1, 38400 baud, 8 data, 1 stop with no parity bits, and XON/XOFF handshake. Also set input translation to CR = CR/LF.

3. Press the reset button on the 121174-1. Verify that the terminal reports – "(c) 2007 USI. S-Record loader. Version 1.0" Followed by a version banner indicating the current version of the board.
4. In TeraTerm, select the option 'File' then 'send'. Select the file provided to you by USI customer service (a typical file name is "08200-22 UT4-288R XP SW V2\_01.S") but do NOT press OK yet.
5. Press the reset button on the 121174-1 card. *IMPORTANT: When the green power OK LED lights, you will have 3 seconds to press the OK button on the TeraTerm screen.*
  - A successful download will show a window indicating that data is downloading for about 20 seconds, following by a version banner being printed indicating the version that was just downloaded.
  - An unsuccessful download will not show the correct version. In this case, repeat steps 4 and 5.
6. Repeat these steps with the other crosspoint card if required.

*MADI Board Configuration*

---

This Appendix contains the following:

MADI IX8 / MADI IX16 Input Modules .....	E-2
MADI Input Slot Board Installation .....	E-4
MADI Input Rear Panel Cabling .....	E-5
MADI OX8 / MADI OX16 Output Module .....	E-6
MADI Output Slot Board Installation .....	E-9
MADI Output Rear Panel Cabling .....	E-10

---

### *MADI IX8 / MADI IX16 Input Modules*

The MADI Input Module is a receiver for a Multichannel Audio Digital Interface (MADI/AES10). The MADI receiver supports 56 or 64 channels of 48kHz digital audio. It extracts a group of 8 or 16 AES3 digital audio signals from the MADI stream and distributes them to the xpoint for routing. The external interface includes a 75-Ohm BNC input for the incoming MADI signal. There is a configuration dipswitch on each board that determines which group of channels (16 or 32) is pulled off of the MADI stream for processing. A MADI IX8 board can be configured for digital audio signals 1-8, 9-16, 17-24 or 25-32. A MADI IX16 is simply a MADI IX8 with an Input Expansion attached that carries 8 more digital audio inputs to the next input slot; therefore, a MADI IX16 board can be configured for digital audio signals 1-16 or 17-32. Four MADI IX8 or two MADI IX16 input boards are required to access all audio channels in a MADI stream.

***The MADI IX8 Input Board and IX16 expansion card and I/O Board (Note that only the MADI Input BNC is used on the I/O Boards.)***

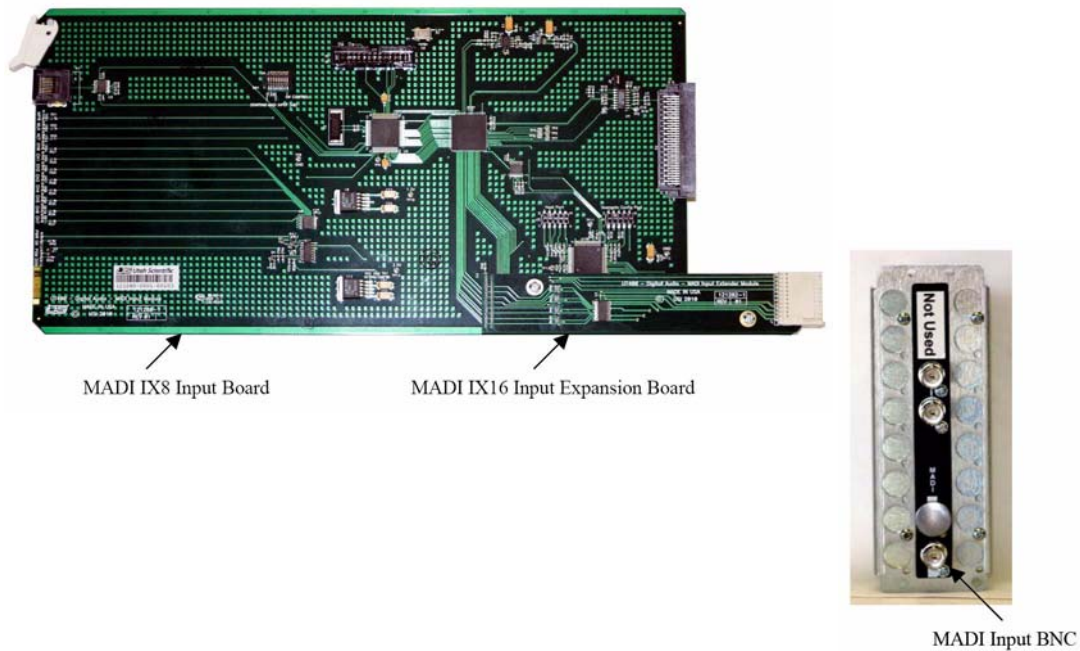

**FIGURE E-1. MADI IX8 and IX16 Input Board and BNCs**

---

### Board Details

- **RJ45 Connector (P1)** - RS232 serial interface (UT400 RJ-45/DB9S adapter - USI #1400000-8) - Baudrate = 38.4K, Data = 8 bit, Parity = None, Stop = 1 bit, Flow = None.
- **MPR LED** - Will illuminate green when a MADI signal is present.
- **MLK LED** - Will illuminate green when the MADI signal is locked to the external reference.
- **ACT LED** - Will illuminate yellow when there is activity on the MADI board control bus.
- **CH0-7 LEDs** - Will illuminate yellow when there is audio data on the corresponding input. MADI IX16 only statuses for the first eight audio input signals.
- **PWR OK** - Will illuminate green when all on board power supplies are functional.
- **PGM DON** - Will illuminate green when the programmable IC configuration is complete.
- **Bypass Jumper (J2)** - When installed the MADI input signal cable equalization is enabled; otherwise the equalization circuit is bypassed.
- **Audio Expansion (P3)** – This is the input expansion connector for the MADI IX16 input board assembly.
- **Dipswitch (SW1)** - This is a configuration switch that determines which group of channels (16 or 32) of the MADI stream is routed to the xpoint board.
  - SW1 -> set to 000 = Audio channels 1-16 (MADI IX8) or 1-32 (MADI IX16) are extracted from the MADI stream.
  - SW1 -> set to 001 = Audio channels 17-32 (MADI IX8) are extracted from the MADI stream.
  - SW1 -> set to 010 = Audio channels 33-48 (MADI IX8) or 33-64 (MADI IX16) are extracted from the MADI stream.
  - SW1 -> set to 011 = Audio channels 49-64 (MADI IX8) are extracted from the MADI stream.

### MADI Input Slot Board Installation

The MADI IX16 input board takes up two slots rather than the single slot used by the MADI IX8 input board. The MADI IX16 comes in a “Non-Seam” and a “Seam” style. There are differences in the spacing between the MADI IX16 and its expansion board depending on which slot it is used in. A MADI IX16 “Non-Seam” style is installed in slots where the rear panel doesn’t have a seam between the two slots being used. A MADI IX16 “Seam” style is used in slots where the rear panel does have a seam between the two slots being used. **\*Caution\*** - *It is important to insert the correct board in the matching slot to prevent motherboard damage.* The MADI IX8 is a single board inserted in a single slot; therefore, it doesn’t require any seam or non-seam spacing management.

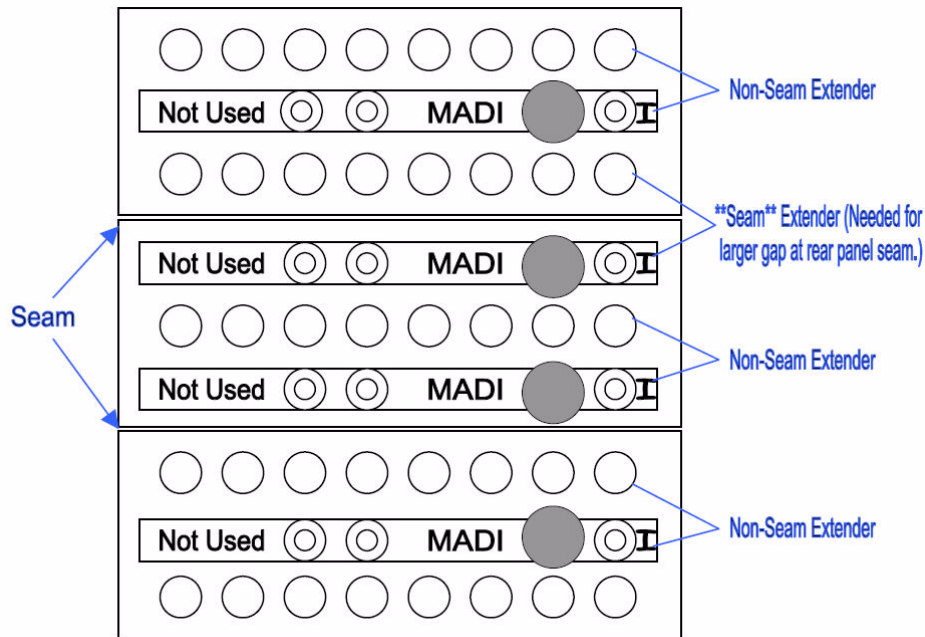

FIGURE E-2. Seam and Non-Seam slot installation - Input

---

### MADI Input Rear Panel Cabling

The incoming MADI signal must be available at each MADI board. In systems that have the MADI IX8, the same MADI signal must be supplied to all four boards. There is currently no loop- thru ports on these boards; therefore, a distribution amplifier may be needed. In systems that have the MADI IX16, the same MADI signal must be supplied to both boards.

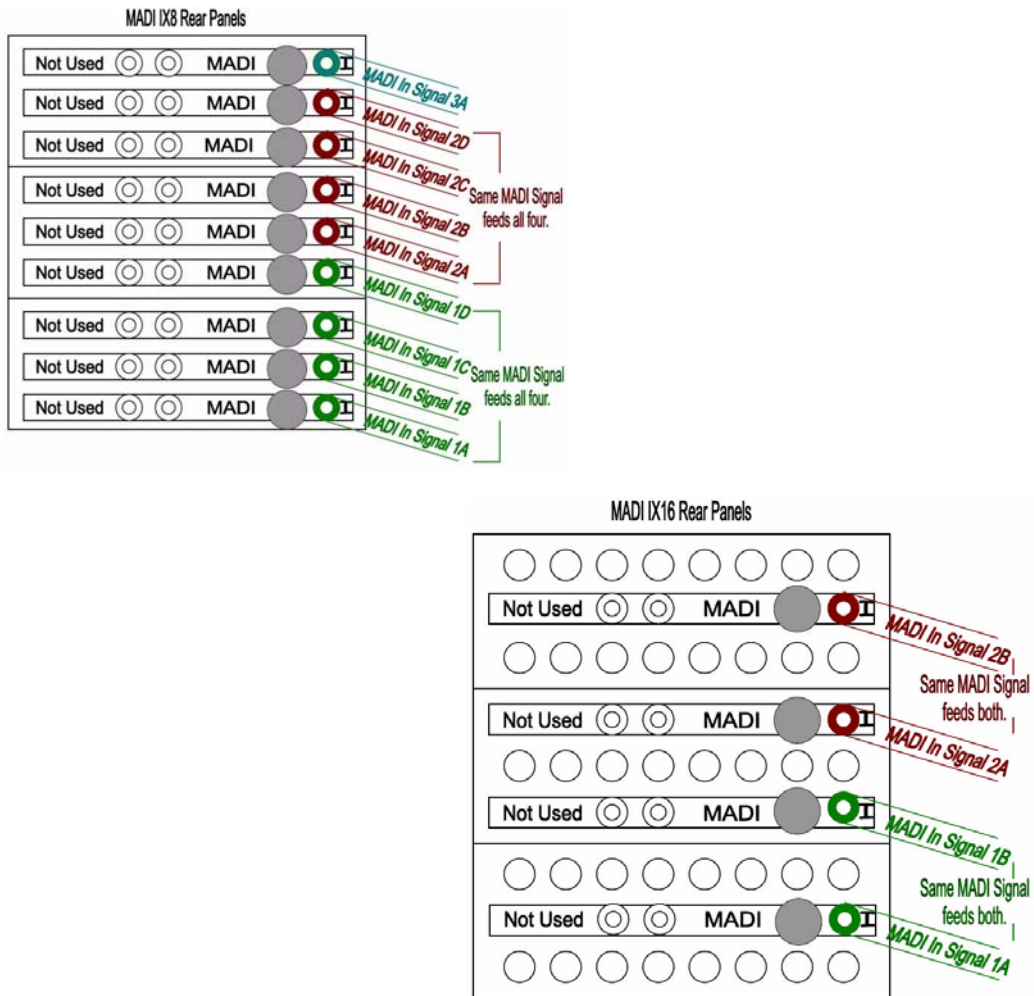
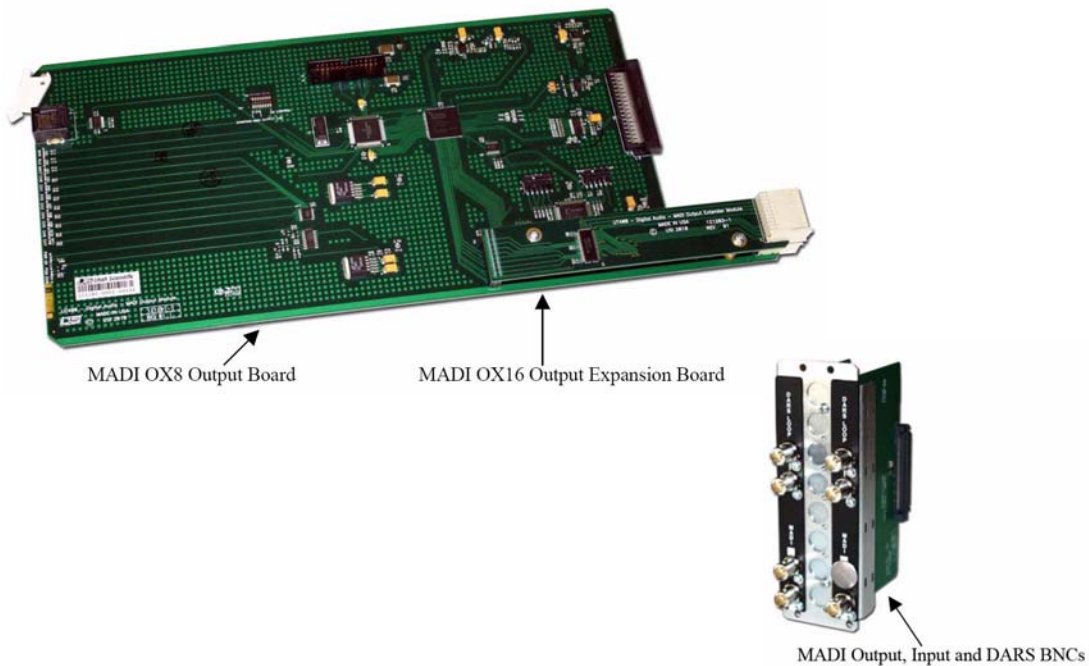

FIGURE E-3. MADI input rear panel cabling

### MADI OX8 / MADI OX16 Output Module

The MADI Output Module is a transmitter for a Multichannel Audio Digital Interface (MADI/AES10). The MADI transmitter supports 56 or 64 channels of 48kHz digital audio. AES3 signals (8 or 16) are received from the xpoint and inserted into a MADI stream for output from the router. There is a configuration dipswitch on each board that determines which group of channels (16 or 32) is inserted into the MADI stream and passed to the output. A MADI OX8 board can be configured for digital audio signals 1-8, 9-16, 17-24 or 25-32. A MADI OX16 is simply a MADI OX8 with an Output Expansion attached that makes 8 more digital audio outputs available from the xpoint. A MADI OX16 board can be configured for digital audio signals 1-16 or 17-32. Four MADI OX8 or two MADI OX16 output boards are required to put all audio channels into a MADI stream. Because each board is capable of inserting either 16 or 32 channels of audio, the first board will insert the first 16 or 32 channels and then output the MADI stream, quarter or half loaded.

***The MADI Output Board and expansion card and I/O Boards (Note the 3 and 4 BNC versions used on the I/O Boards.)***



**FIGURE E-4. MADI OX8 and OX16 Output Module**



The MADI output BNC for that board is then fed to the MADI input BNC of the next board. In the case of the MADI OX8, the MADI output is connected to the next MADI input enabling 16 more channels of audio to be inserted into the outgoing MADI stream. Each board output will add a quarter of the audio signals to the MADI stream for a complete 64 or 56 channel MADI output. For the MADI OX16 the MADI output is connected to the next MADI input enabling 32 more channels of audio to be inserted into the outgoing MADI stream. Each board output will add half of the audio signals to the MADI stream for a complete 64 or 56 channel MADI output. The external interface includes three or four 75-Ohm BNCs of which the two are loop-thru DARS references and the other one or two are a MADI output and input. In the four BNC version of the rear panel, the remaining BNC is the MADI input for the partially loaded MADI signal from the previous board.

### ***Board Details***

- **RJ45 Connector (P1)** - RS232 serial interface (UT400 RJ-45/DB9S adapter - USI #1400000-8) - Baudrate = 38.4K, Data = 8 bit, Parity = None, Stop = 1 bit, Flow = None.
- **RPR LED** - Will illuminate green when a DARS reference is present.
- **RLK LED** - Will illuminate green when an incoming MADI signal is locked to the external reference.
- **MACT LED** - Will illuminate yellow when there is activity on the MADI board control bus.
- **CH0-7 LEDs** - Will illuminate yellow when there is audio data on the corresponding output. MADI output board only statuses the first eight audio input signals.
- **PWR OK** - Will illuminate green when all on board power supplies are functional.
- **PGM DON** - Will illuminate green when the programmable IC configuration is complete.
- **Audio Expansion (P3)** – This is the output expansion connector for the eight AES signals from the next audio slot. Two audio slots are required to access the 16 AES signals.

- **Dipswitch (SW1)** - This is a configuration switch that determines where the group of channels (16 or 32) is added to the of the MADI stream.
  - SW1 -> set to 000 = Audio channels 1-16 (MADI OX8) or 1-32 (MADI OX16) inserted into the MADI stream.
  - SW1 -> set to 001 = Audio channels 17-32 (MADI OX8) inserted into the MADI stream.
  - SW1 -> set to 010 = Audio channels 33-48 (MADI OX8) or 33-64 (MADI OX16) inserted into the MADI stream.
  - SW1 -> set to 011 = Audio channels 49-64 (MADI OX8) inserted into the MADI stream

### MADI Output Slot Board Installation

The MADI OX16 output board takes up two slots rather than the single slot used by the MADI OX8 output board. The MADI OX16 comes in a “Non-Seam” and a “Seam” style. There are differences in the spacing between the MADI OX16 and its expansion board depending on which slot it is used in. A MADI OX16 “Non-Seam” style is installed in slots where the rear panel doesn’t have a seam between the two slots being used. A MADI OX16 “Seam” style is used in slots where the rear panel does have a seam between the two slots being used.

**\*Caution\*** - It is important to insert the correct board in the matching slot to prevent motherboard damage. The MADI OX8 is a single board inserted in a single slot; therefore, it doesn’t require any seam or non-seam spacing management.

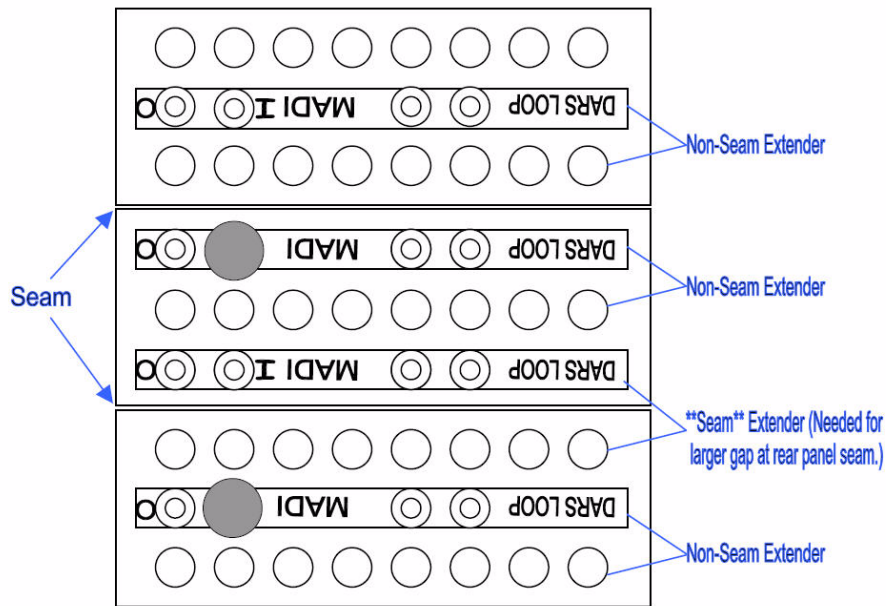

FIGURE E-5. Seam and Non-Seam slot installation - Output

### MADI Output Rear Panel Cabling

The outgoing MADI signal is derived from digital audio signals inserted into a MADI stream by more than one board. This requires looping the partially loaded MADI streams into the next board until all 64 or 56 channels are available to the output of the router. In systems that have the MADI OX8, there will be three cables looping the output to the input of the next board. In systems that have the MADI OX16, there will be one cable looping the output to the input of the next board.

The last output BNC will carry the fully loaded MADI stream out of the router. There are two loop-thru Digital Audio Reference (DARS) BNCs available at each board. A distribution amplifier is recommended when more than eight boards are being looped with the DARS signal.

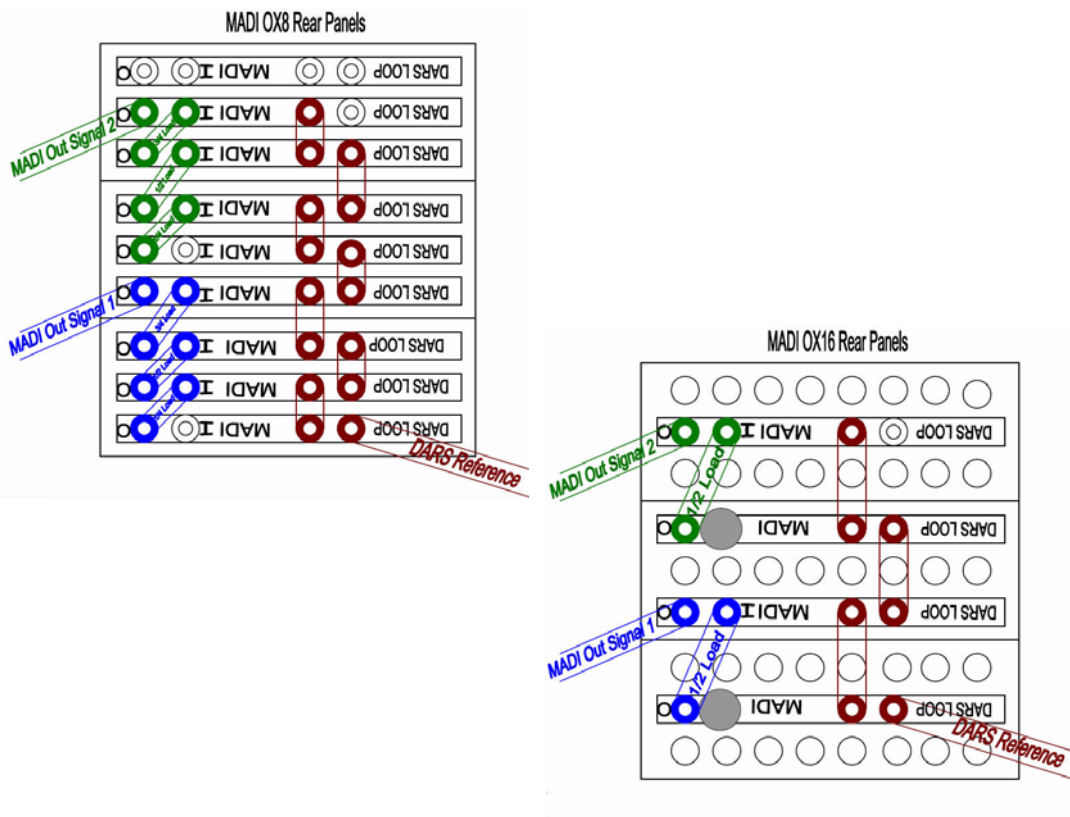

FIGURE E-6. MADI Output rear panel cabling

---

**MADI IX8 / MADI IX16 Input Modules**

---

---

**MADI Board Configuration**

---

---

---

## Index

### Numerics

0V 2-22  
10 X 10 switching matrix 1-7  
26-pin high-density connector 2-16  
3G Input Card 4-7  
3G Output Board 4-15  
-48V 2-22

### A

Abbreviations 1-4  
Active FPGA B-3  
AES Breakout Panel C-2  
AES reference cabling 2-9  
AES reference signal 2-9  
alarm indicators  
  fan 3-8  
alarm specifications A-7  
alarms  
  system controller 5-8  
analog to digital board 4-3  
Audio Crosspoint board  
  adjustments 4-39  
  description 4-37  
  LED indications 4-38  
  test points 4-43  
Audio Input board 4-27  
Audio Output board 4-28  
audio subsystem  
  troubleshooting table 5-5

### B

basic system operation 3-5  
breakaway takes 1-6  
Breakout Panel C-1

### C

cable connection recommendations 2-12  
cable installation  
  digital audio input and output 2-16  
card ejectors 3-7  
card removal and replacement 3-7  
Checking Input and Output  
  debug B-9  
connector suppliers A-9  
control panel  
  troubleshooting table 5-9

control specifications A-6  
control subsystem troubleshooting table 5-7  
crosspoint board fuse assembly 4-42  
crosspoint card  
  firmware upgrade D-1  
  removal and replacement 3-7  
crosspoint reset button 4-39

### D

DC Connectivity 2-24  
DC power specifications A-2  
Debug  
  cable B-2  
  port B-1, C-1  
debug port 4-39  
Definitions  
  control panel 1-5  
  destination 1-5  
  display 1-5  
  high definition 1-6  
  hot swappable 1-5  
  monitor 1-6  
  output 1-5  
  serial digital 1-6  
  signal level 1-5  
  source 1-5  
Deluxe Output board 4-29  
digital audio specifications A-4  
digital video specification A-3  
Digital Video to analog converter output card 4-10  
dip-switch  
  audio crosspoint board 4-39

### E

equipment installation 2-3  
External PS Status B-12

### F

fan service 3-8  
Firmware Upgrade D-1  
FPGA Memory Status B-5  
frame boundary 2-9  
frame connection  
  SC-3 to Utah-400 2-7  
fuse  
  crosspoint board 4-42

### G

Ground 2-22

---

## H

hardware checkout 2-24  
Hardware Status Display B-11  
HD-output board 4-10  
high definition SDI video specifications A-5

## I

input backplane 2-12  
Input Modules  
    MADI IX8 and IX16 E-2  
input power specifications A-2  
installation  
    audio input and output recommendations 2-16  
    video input and output 2-12  
Interface board (midplane)  
    general description 4-23  
IO Information  
    debug B-10

## L

LED Indications  
    audio crosspoint board 4-38  
    Deluxe audio output board 4-30  
    fiber output 4-19  
    power supplies 4-25  
    SD video and HD (multi-rate) output 4-11  
    SD video and multi-rate input 4-4  
    Time Base module 4-40  
    video crosspoint card 4-21  
loop lock 4-40

## M

MADI  
    input rear panel cabling E-5  
    input slot board installation E-4  
    output rear panel cabling E-10  
    output slot board installation E-9  
    OX8 and OX16 output module E-6  
MADI IX16 E-2  
MADI IX8 E-2  
Main Menu  
    debug B-4  
matrix backplane 2-12  
Multi-Rate input board 4-3  
Multi-Rate output board 4-10  
MX-Bus cable installation 2-7

## O

output backplane 2-12

## P

PGMXPT1-2 4-38  
PGMXPT3-4 4-38  
physical specifications A-8  
pin-out  
    26-pin high-density connector table 2-19  
    DB-26 high-density illustrations 2-20  
power connections 2-21  
power subsystem troubleshooting table 5-6  
power supplies 4-24  
power supply  
    audio crosspoint fault indications 4-38  
power supply alarms 5-6  
PRIACT 4-38  
PWROK 4-38

## R

rack frame layout 2-4  
rack frame mounting 2-3  
Reclocking Input Expansion Card 4-6  
Ref OK 4-40  
reference signal 2-9  
reference specifications A-5  
regulatory specifications A-8  
Router Crosspoint Status  
    debug B-6  
routing switcher basics 1-6

## S

sample configurations 1-11  
SC-4 Control 3-2  
scangate I/O 4-38  
scangate active 4-30, 4-38  
SD video input 4-2  
SD-output board 4-9  
SECACT 4-38  
SGACT 4-30, 4-38  
SGI-O 4-38  
signal level  
    definition 1-8  
signal level setup 2-9  
SMPTE Alarm A-6  
Software verification  
    debug B-5  
Specifications  
    alarms A-7  
    connector suppliers A-9  
    control A-6  
    digital audio A-4



---

---

- digital video A-3
- high definition SDI video A-5
- input and DC power A-2
- physical A-8
- reference A-5
- regulatory A-8
- switching matrix 1-7
- system configurations 1-11
- system controller alarms 5-8
- system weight 2-2

## T

- Tension Clamp Connector C-4
- terminal block 2-22
- terminal settings
  - debug port B-2
- Terms 1-5
- test points
  - audio crosspoint card 4-43
- Time Base module 4-39
- troubleshooting chart 5-2
- troubleshooting tables
  - audio subsystem 5-5
  - control panel 5-9
  - control subsystem 5-7
  - main 5-3
  - power subsystem 5-6
  - video subsystem 5-4

## U

- unpacking 2-2
- Utah-400
  - standard configuration 2-17
- UTAH-400 3G Input Card 4-7
- UTAH-400 3G Output Board 4-15
- Utah-400 routing matrix 1-9

## V

- Video Crosspoint board
  - description 4-21
- Video crosspoint board (redundant) 4-21
- video crosspoint LED's
  - power OK 4-21
  - scan data active 4-22
  - voltage failure 4-21
- video subsystem
  - troubleshooting table 5-4

## W

- Wire Preparation
  - breakout panel C-3
- wiring
  - recommendations 2-18